

KELLER INSIGHT



**SUSTAINABILITY @
KELLER SEN**

Rethinking a familiar topic

SMALL BUT NICE

our smallest region
in focus

#BUILDINGTOGETHER

Apprenticeship campaign
at Keller

Well known challenges, new conditions

Over the last few months, I have visited many construction sites in different countries. Not just in our business unit but throughout Europe. I talked to young technicians about their jobs and the current working environment, and got an insight into how the new generation thinks and acts.

Keywords such as 'digitization', 'lean', 'work-life balance' and 'flexible work arrangements', came up quickly. In addition, I heard their frustrations about feeling overworked, having too many tasks that need to be done all at the same time, a lack of role and job descriptions and the fear of burn-out.

All very valid points, of course, which make you pause for thought. We want our employees to be content in the work that they do.

As a so-called 'baby boomer', I have to be honest that I find it difficult to relate to some of the statements. I'm not surprised that current social issues are alive in our company – after all, our 'Keller microcosm' is a part of wider society. But I do think back to my time as a (young) site manager and remember that I found some of the more challenging aspects of the job interesting enough to feel satisfied. It might sound strange to many, but I'm not sure I ever considered work-life balance or flexible working arrangements!

Now you are probably saying: "yes, but that was back then" and "Mr Körbler, you simply belong to a different generation" and, of course, you are right. I am a 'baby boomer' but knowing myself, that would still be my approach today.

I remember that I enjoyed facing new challenges every day, observing the machines, getting to know our products and planning and acquiring the proper procedure for the different soil conditions and, above all, getting in touch with great people every day to also solve problems on the construction site. And yes, theory and paperwork were also part of it.

I'm proud that our great young colleagues confirm that they like exactly these things in their job, too, and are passionate about it, but with new conditions for better satisfaction at home and work.

So what's changed? Is it society in general? The fast-moving world? Is it generations X, Y (Millennials), Z, or us, the baby boomers? Honestly, I don't know. The fact is that four generations, which at first glance could not be more different, are currently coexisting in the job market. Actually, though, we all want the same thing: satisfaction and fun at work, and in our personal lives, too. One cannot exist without the other. So, if we all work together, in harmony, we can achieve what is most important – to be satisfied.



Many thanks to everyone who provides support to me every day and ensures we can carry out so many interesting projects across Europe. It is precisely these people who make me happy – from the office employee to the worker on the construction site. Without them, none of what you will read on the following pages would be possible.

Ihr Andreas Körbler

MASTHEAD

"Keller Insight" is a magazine by Keller Grundbau Ges.mbH and affiliated companies.

Owned and published by:
Keller Grundbau Ges.mbH,
Guglgasse 15, BT4a / 3. OG
1110 Wien
E-Mail: info.at@keller.com
Editor: Marina Vacali

Design: REICHMANN D.esign
Print: VSG Direktwerbung GmbH
Industriestraße B 18
2345 Brunn am Gebirge
Austria

Please send ideas and suggestions to the publisher. All rights and modifications reserved.

If you no longer wish to receive our magazine in the future, please send us an email to info.at@keller.com

04



AREAS AND DEPARTMENTS

Sustainability – Rethinking a familiar topic	Keller Switzerland – Confident for the future
Wooden ductile piles – existing technology reborn!	HSEQ service is our success
KFS grew into Finland’s leading expert in special foundation works	When digitization contributes to construction site safety
Keller Geotechnica in Romania – Who we are and what we do	New yard in Věžky

36

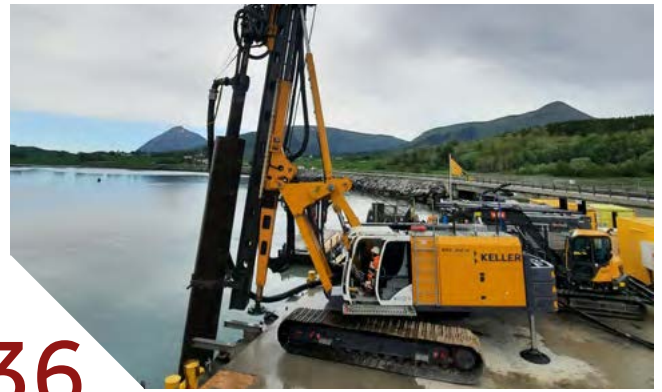

WHAT WE DID IN EUROPE

Drilled piles for the new Engeløya Bridge – A project up in the North	Italy as a vibro market
Test field ‘Kolkajen’ in Stockholm – Yes, you can use ‘wet soil mixing’ in the water	Expansion of Würth logistics centre – Foundation for a new high-rack storage warehouse and office building
Keller Ductile Piles for Sustainable Food Production	Infrastructure projects in CZ with vibro
Samsung relies on Keller	Bratislavské podhradie Vydrica
Flood protection – One solution, many techniques: slurry cut-off wall, JG lamella wall, JG full columns, mixed-in-place wall	Refurbishment of the rail line “Maribor-Spielfeld section” in Slovenia

20



WHAT WE DID IN AUSTRIA

Wagenham substation – “No stone remains unturned” – soil improvement in loose soils with cavities	S7 Fürstenfelder Schnellstraße East section – construction lot 03
Vienna underground – U2xU5 line crossing – Precision work with millimetre tolerances	Cut-and-cover tunnels in Scheffau and Prutz
Alleviation of the traffic situation in Golling – ÖBB Golling line improvement	Bregenz lake stage – Keller becomes part of the 2022 Bregenz Festival
Zirkusgasse 46-48 Bundesrealgymnasium Wien II	KM 5 Bregenz – History meets modernity
	A14 AST – Rheintal Mitte

54



WHAT WE DID FOR US

#buildingtogether – Apprenticeship campaign at Keller

Our events in SEN – The masks are (finally) off

25 years – time for a big celebration!

58



INTERNATIONAL

HS2 is Europe’s largest infrastructure project costing around £100 billion.

Keller improves employee wellbeing with first-ever global health initiative

Sustainability

Rethinking a familiar topic

A company that is successful in the long term is also meant to be sustainable. Keller SEN is successful – but are we also working sustainably in modern thinking? What does that mean for a company that focuses on special foundation works? Is it even possible to implement all 17 UN Sustainable Development Goals?

Keller Group has chosen to focus on eight of these goals, which are largely described by the 4 Ps, and has issued a clear statement in favour of sustainable work, thus defining the target for all business units.

Thomas Kirchmaier – Keller SEN



► At Keller SEN, our management decided in early 2022 to add Thomas Kirchmaier, our former product line manager for “bored piles”, for the implementation of the sustainable development goals. By mid-year, all of the necessary organisational steps had been taken and the leadership of the product line “bored piles” was passed on to Johannes Zauner.

Together with Peter Freitag, our Lead Environmental Geotechnics, they began their work by organising a CO₂ workshop and have continued with the development of a “sustainability priority list” and ideas that are to be implemented quickly. The primary focus is on measures that will improve our CO₂ footprint, one of the most important targets that the Group has defined.

SEN is starting with a three-point strategy:

1. Precise data collection for our energy consumption at the office locations and storage sites (electricity and heating) will help us identify potential savings, which will also be defined as part of the next energy efficiency audit. New measurements for our energy inputs (electricity and diesel fuel) will also be made in future, with the same objective in mind.
2. General sustainability initiatives that benefit not only the business unit, but also their employees, are under discussion; some have already been implemented. The new policy for procuring company cars has increased the attractiveness

People

We operate in a way that respects people and their health, safety and environment, always striving for zero harm. Our motivating and inclusive culture helps everyone thrive, and makes us a good employer that people are proud to work for.

Projects

We continually innovate to support low carbon, low impact construction, actively transforming our product portfolio to help our customers use fewer resources, reduce their carbon emissions and have less environmental impact.

Planet

We are helping to build a sustainable future by using less resources and reducing waste across our operations, whilst playing a positive role in our local communities and wider society.

Profit

We are making sustainability core to our business to differentiate us from our competitors and help achieve long-term profitability and growth.

of electric cars. We are changing the Christmas vouchers for our Austrian employees to a new, more sustainable system and are considering introducing an “energy bonus” that aims to reward efforts to conserve energy.

3. We are examining the extent to which we can reduce our CO₂ footprint by using alternative materials, as well as how we can reduce the amount of waste and materials that require land-filling.



The activities that are being pursued – some of which have already been implemented – include:

ad 1: In early 2022, we launched a CO₂ emissions analysis at the Prutz project in Tyrol, where we used the “EFFC CO₂ Carbon Calculator” – developed with key input from Keller – to calculate the CO₂ footprint. By comparing the target CO₂ data from the original inquiry with the CO₂ data of the alternative that we developed and offered, we were able to demonstrate a significant reduction in CO₂ emissions with the proposed Keller alternative. This shows that well considered alternative projects can save not only money but CO₂, too.

As part of our energy efficiency audit, we are examining methods for measuring and documenting our energy consumption with the aim of creating a practical energy reduction plan that can be implemented quickly and help us cut electricity consumption by office locations and yards by around 10% as soon as the end of 2022. This includes an investment in a 184 kWp expansion of the existing photovoltaic installation at the yard in Söding, for instance, as well as converting our lighting systems to LED technology.

ad 2: 57% of all company cars purchased since the start of 2022 are electric cars. This not only improves the CO₂ footprint caused by company business trips, but also offers advantages to employees due to tax benefits. In addition, powerful charging stations will be installed at all office locations wherever possible.

In Austria, we are moving our annual gift vouchers to more sustainable offering at “www.bauernladen.at”, which gives priority to sourcing regional products, which in turn cuts down on transportation distances and supports the Austrian economy.

ad 3: First and foremost, this involves studies to find out whether cement with a high percentage of klinker can be replaced by “green” cement types, whose manufacturing only emits a fraction of the CO₂. Cement-free binding agents are also being investigated in this context. Results from initial trials are promising and lead us to believe that we can cut CO₂ emissions by at least 20% for Soilcrete® and injection applications. In addition, our experiments aimed at minimising the amount of backflow of grout that must be land-filled, by using filter chamber presses and centrifuges, have been extremely positive. At a construction site in Vienna (see page 26), we compared the amount of “conventional” waste returned via suction tanker with the amount of dry material after treatment with a newly purchased centrifuge that was configured to our requirements. A 50% reduction in the amount of material requiring land-fill disposal is absolutely realistic. This will not only help cut removal and land-fill costs, but also reduce CO₂ emissions. The final report on these experiments will be presented shortly. We are also working on using the dry material as a reusable raw material.

In another project, the driven piles product line investigated the use of wooden ductile piles, in which we combined wood-piles with our successful “Keller ductile pile” product to improve its CO₂ footprint (see page 6).

For us, living sustainably means calling on all Keller SEN employees to support us with their suggestions and ideas. While we certainly can’t implement everything (right away), we will take this responsibility seriously on behalf of management, not only to pursue the Keller Group’s sustainability strategy, but also – and above all – because we bear responsibility for ourselves, our families, our children and our environment.

GRAPHIC:
construction site Prutz

This is equivalent to:



This can be compensated by:

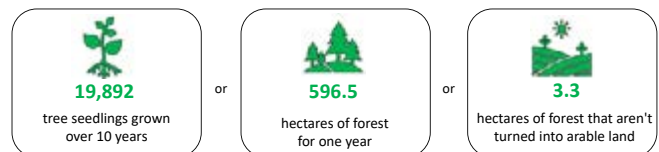

Wooden ductile piles existing technology reborn!

In times of interrupted supply chains and increased awareness for sustainability in special foundation works, the “driven pile” product line at Keller explored this topic and took the first steps toward this (old) new ground.

Martin Hayden – Keller SEN
Dr. Matthias J. Rebhan – TU Graz
Dr. Sebastian Hirschmüller – TH Rosenheim



► Over the course of a “pile-constructor existence”, we are repeatedly confronted with the topic of timber piles. Several years ago, for instance, we tried to convince a structural engineer in Vorarlberg, Austria, of the disadvantages of the tendered timber pile foundation, to shift the conversation to our “standard product”, the ductile pile, in the hopes of winning the tender. Our main arguments against timber piles were their lack of durability in places with changing groundwater levels, the large driving equipment required to drive tree trunks, which weighs more than 40 tonnes and the associated higher costs for building the working platform. In addition, the costs of extending the individual segments of timber piles are much higher.

Although we were certain that our arguments would prevail, he gave us a succinct reply: “You know, Mr. Hayden, a timber pile is so cheap that the additional costs of the working platform can easily be compensated for. With regard to durability, I can only say that these timber piles will last more than 100 years, and the worms will have consumed even me by then! When the timber piles are manufactured properly, a technical useful life of several thousand years is even possible, as proven by the pile dwellings in Überlingen on Lake Constance and

BROKEN DRIVEN TIMBER PILE

due to natural, unforeseen “predetermined breaking point” (branch)



Hallstatt.” We couldn't argue with that and no ductile piles were executed.

The advantages of timber piles are clearly rooted in the sustainability of the product – its positive contribution to reducing CO₂ emissions, its regional availability and its excellent bearing capacity properties, particularly in cohesive soils.

This is in contrast to the well-known disadvantageous conditions of timber pile production, which we are attempting to counter by using modern, innovative wood and material technologies. By using innovative wood impregnation methods with polymerised, polyvalent



INITIAL TESTS FOR DRIVING POLYMER CEMENT-COATED, impregnated timber piles.



SECOND TRIAL: COMBINATION OF TIMBER PILE with ductile pile attachment in the area of changing groundwater levels

alcohols to stabilise the dimensions, in combination with a polymer cement coating on the wood, we hope to combine the advantages both of ductile and timber piles.

The initial trials took place in early summer at a construction site in Graz. Here, we tried to impregnate "waste wood elements" from veneer wood production and coat it with polymer-modified cement to increase its durability. Unfortunately, we discovered that growth-related flaws in the wood (branches) in combination with insufficiently large pile diameters made driving with the "standard equipment" impossible.

One exciting effect we noticed, however, is that a cement-coated timber pile with a diameter of approx. ten centimetres that had been driven into the ground for two metres only, could not be pulled out with a pulling force of 2.5 tonnes.

The second trial, in late summer, also took place in Graz, which delivered promising results with regard to driveability using different driving heads, the durability of the timber piles and the installation effort required by the two combined pile systems. The next steps will involve a review of the end bearing capacities.

The main benefit of the ductile/timber driven pile combination lies in the use of "light standard equipment", with extremely high ease of connection for the individual pile segments and an increase in the technical useful life resulting from the use of a "ductile attachment pipe" in places with changing groundwater levels.

Thanks to the combination of academic expertise from TU Graz (Dr. Rebhan) and TH Rosenheim (Dr. Hirschmüller) and the many years of experience in driven pile production by Keller, we have laid the cornerstone for further pioneering innovations.

CONNECTING TWO TIMBER PILES with a coupling sleeve





KFS grew into Finland's leading expert in special foundation works

The plans to purchase a stabilising machine started a partnership that has made KFS Finland, in which Keller owns a 50% share, the number one company in demanding special foundation construction projects in Finland. Currently, challenging stabilisation, pipe piling and drilled piling projects employ more than 100 professionals at dozens of sites and seven offices in Finland.



► The year 2022 marks the 10th anniversary of KFS Finland. In fact, the company's history extends all the way until 2002, when Fin-Seula – a company focusing on demanding foundation construction – was established.

"Ten years ago, we wanted to buy a stabilising machine for Fin-Seula. We did not get a licence, and when we were looking for one, we encountered a company named Keller", Director Seppo Valtonen explains. Instead of buying the machine from Keller, we ended up establishing a new company together. That is how "Keller-Fin-Seula" – the joint venture KFS Finland Oy – was born.

A committed team turns the impossible into reality

In Finland, construction is focused on places where the foundation conditions are challenging. This allows for the existence of KFS Finland and the sector in which it operates.

"We build where many others cannot, as they lack the necessary skill and equipment. We have managed to get the right people to work for us. Everyone at our company has had the opportunity

to grow and develop into an expert in the field. The team here is highly committed, and they make the impossible a reality”, says the company CEO Tommi Hakanen.

The four distinct seasons in Finland give special foundation works an additional twist. Site Manager Tuomas Nyberg thinks back to a stabilisation contract in Kittilä, Northern Finland, a few years ago.

“It was minus 25 degrees, but the sunrise brought the temperature above zero”. Extreme conditions, high temperature variations and frozen soil in the winter are tough on the equipment and the crew. Our work emphasises the importance of advanced planning.

Green values and internationality as part of our operations.

KFS Finland’s operations reflect global instability, e.g. through materials and fuel costs. The reduction of waste and green values are what clients also increasingly want. “This also emphasises planning by optimising quantities according to the right need at the right time. Similarly to other companies in this sector, we have work available for skilled workers. For current and new employees, KFS Finland’s strengths include good contacts and internationality, which we can get through Keller”, Hakanen adds.

Some highlights of ongoing challenging projects

At the **Melo hydropower plant along the Kokemäenjoki river**, special foundation construction experts are executing a unique project for repairing the dam for the Melo hydropower plant in Nokia, Finland. The embankment dam, built in 1971, and other contractors have strengthened previously detected changes by injecting concrete mix, as well as bentonite. KFS Finland is building a drilled pile wall, embedded into the rock at the bottom, which will ensure the tightness of the dam. The preparations for the project and piling started in March. The construction will be finished by the end of this year.



REPAIR WORKS AT THE MELO HYDROPOWER PLANT
in Nokia, Finland

The highest investment in the history of Finnish forestry, a new bioproduct mill, is being built in Kemi. The completed mill will be the most effective wood processing facility and is the biggest piling worksite in Finland. KFS Finland will carry out reinforced concrete piling, steel-driven piling and bored piling at the site.

In the **Crown Bridges project**, KFS Finland’s professionals are participating in the construction of the longest, highest and longest-spanning bridge, as well as the nearby Finkensilta bridge in the Finnish capital of Helsinki.

In **Helsinki**, an overpass is being built above the busiest railway section in Finland. This bridge will be completed in three sections, and KFS Finland will handle the drilled piling for its foundations between the tracks.

The **Sulkavuori wastewater treatment plant** is a large-scale project, carried out by six municipalities and cities. At the Viinikanlahti wastewater pumping station worksite, KFS Finland will deliver drilled pile walls, jet grouting and driven piling.

KFS Finland Oy in brief

- An associated company equally owned by Keller Group plc and Kreate Oy, a specialist in demanding infrastructure construction
- Established in 2012
- More than 100 employees
- Revenue of more than EUR 40 million (2021)
- Services: jet grouting, bored piling, stabilisation, supporting walls and anchoring, geotechnical monitoring
- KFS Finland employs more than 100 professionals at dozens of sites and seven offices in Finland. The head office is located in Tuusula Southern Finland.

ON THE PICTURE:

Equipment Manager Simo Koskinen (on the left), Site Manager Viivi Rautakoski, Site Manager Paavo Tikka, CEO Tommi Hakanen and Design Manager Jyrki Pihlajamäki are shown in the image.





Keller Geotehnica in Romania

Who we are and what we do

Keller entered the Romanian market in 2007. Over the last 15 years, we have made a name for ourselves as a reliable, stable partner for the project planning and handling of special foundation projects. On the occasion of our 15th anniversary, we'd like to introduce our team and some of our core competencies.

Michael Flor – Keller SEN

DESIGN & ACQUISITION:

Stefan Guran – team leader

SITE MANAGEMENT:

Robert Vincze – Site manager

George Dulama – Bauleiter

Florin Archip – Bauleiter

Nicoleta Calin – Commissioning & Qualification Engineer

ADMINISTRATION:

Radu Dumitriu – Regional Manager

Diana Manu – Assistance & Finance

Iuliana Radu – Assistance

► Keller Geotehnica has its head office in Bucharest, from which it serves all of Romania. It is part of the Keller SEN business unit and acts as an independent company, with local staff and equipment. Our construction sites are spread over the entire country.

Like in other regions, one of our strengths is our broad product portfolio, which can be complemented by the business unit's partner countries at any time.

Thanks to our competent local design department, we are capable of planning projects involving geotechnical challenges in house, and therefore of offering full design-and-build solutions. Here, as well, broad-based internal knowledge-sharing with our central design department ensures that international experience is incorporated in the design process.

A major focus is the ongoing, sustainable development of our company, which is reflected in both the constant enhancement of our equipment fleet and continuing education programs for our employees.

Romania is a country with major infrastructure projects, as well as a strong private investor sector with a focus on building offices, housing and industrial halls.

As such, our projects include such wide-ranging measures as ground improvement with vibro replacement, special foundation works with bored piles and ductile driven piles, and shotcrete retaining walls incl. soil nailing and excavation pit support.

Following market trends, we have begun offering entire excavation pit solutions as a general contractor in recent years.

One advantage of these comprehensive packages is that they give the customer a longer lead time for tendering the building construction. In addition, the geotechnically relevant interfaces between drainage, excavation and special foundation work all come from a single source, making them easier to coordinate.

It is worth mentioning that we are a construction company with a focus on design and execution. As such, we can only approach full excavation pit solutions that include a significant share of special foundation work.

We pursue all projects with the same enthusiasm, accuracy and attention to detail, regardless of their size and complexity.

Over the last 15 years, Keller Geotechnica has established itself as a serious market player, giving us sufficient motivation to expanding this position in future and remaining faithful to our strategy: **global strength and local focus**

Contracts in which entire excavation pits are tendered often include the following solutions as a one-stop shop:

- Project planning for excavation pit support
- Project planning for foundations
- Project planning for ground water treatment
- Execution planning
- Execution of the excavation pit support
- Execution of the foundation works
- Execution of the excavation
- Placing of the lean concrete

Keller Geotechnica Srl
 Strada Uruguay 27 et1 ap2
 Bucuresti Sector 1
www.kellergeotechnica.ro

TYPICAL EXCAVATION PIT SUPPORT

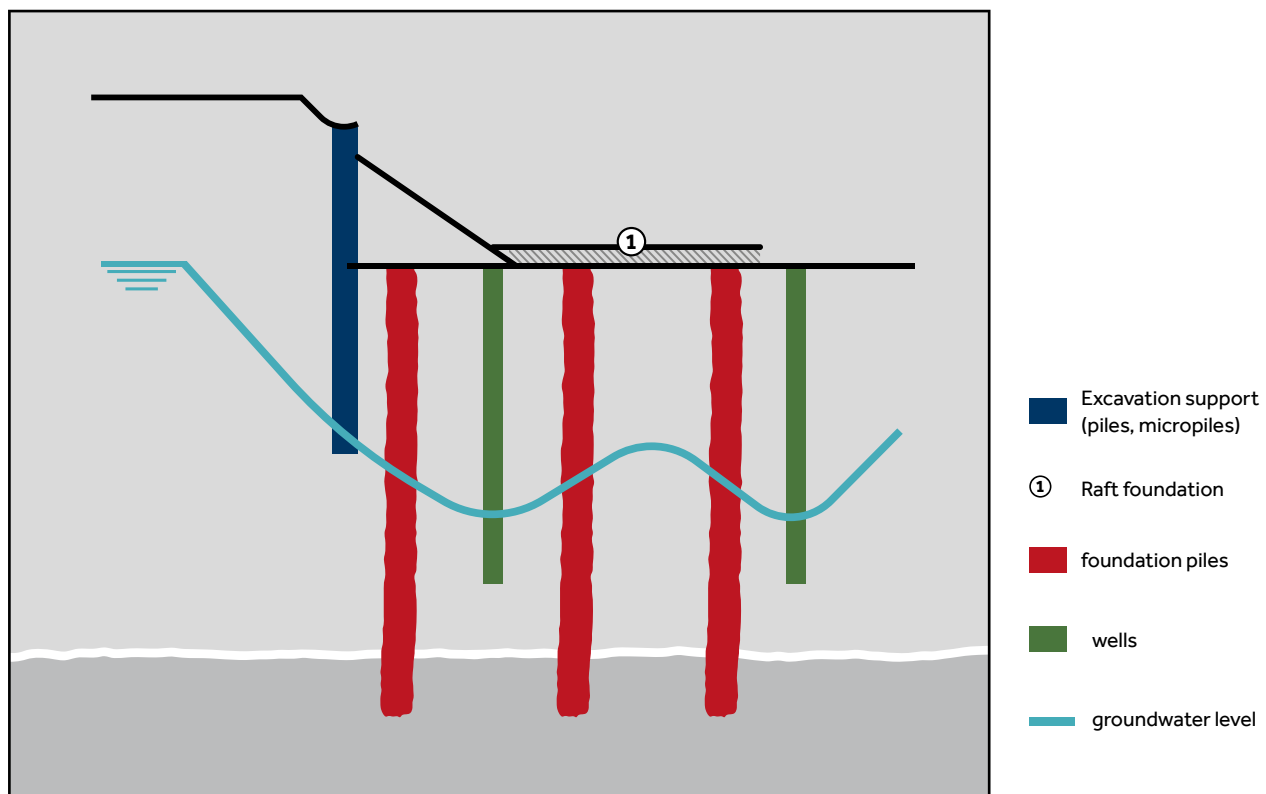

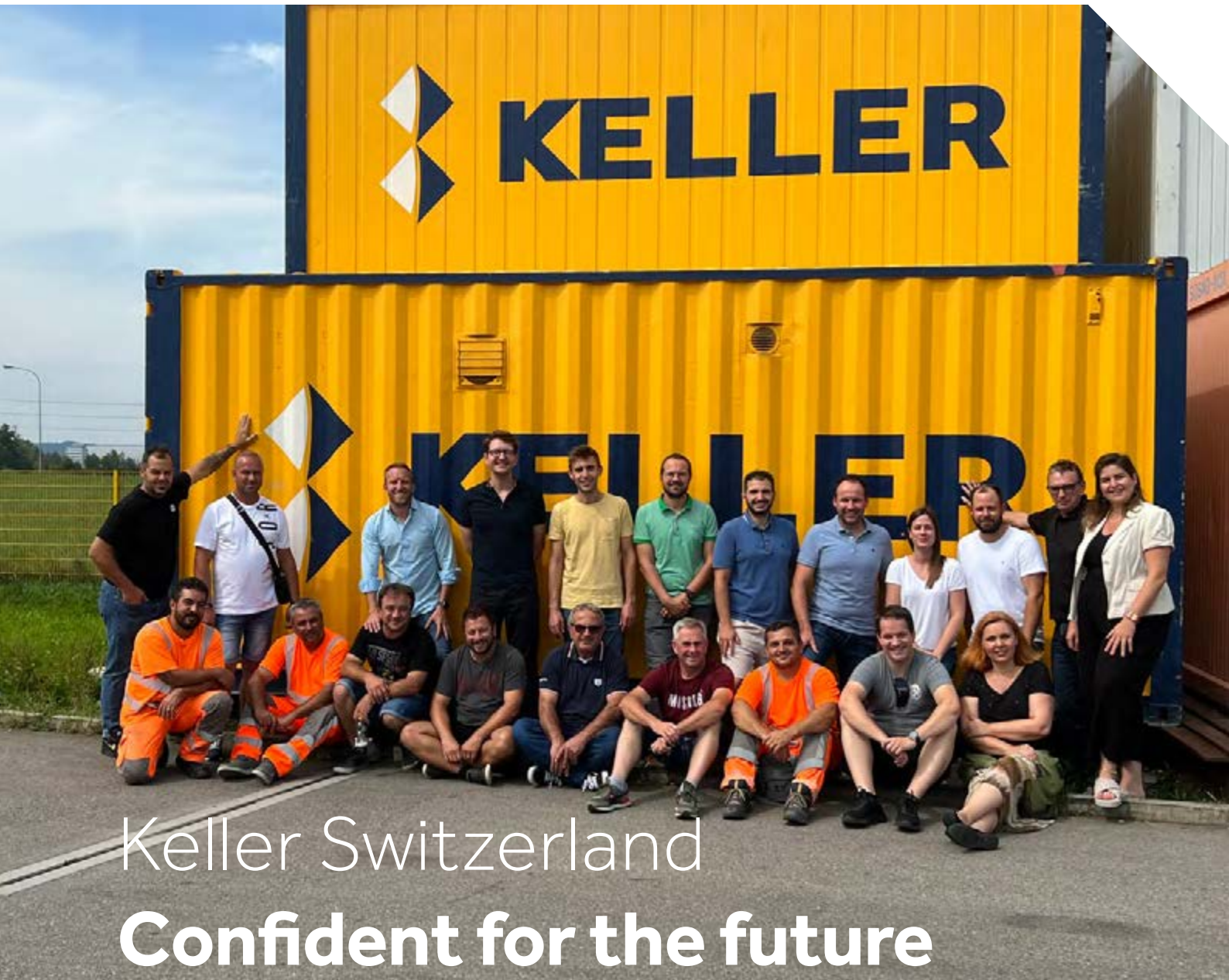

Keller Switzerland Confident for the future

During the pandemic years, the Swiss construction industry demonstrated its robustness. Meanwhile, there is no doubt about how important this sector is for the Confederation. Keller Switzerland proved able to master this extraordinary time – and we now look toward the future with confidence.

Ester Gutierrez – Keller-MTS, Regensdorf

► The construction industry in Switzerland was very stable over the last two years, despite the extraordinary circumstances, holding up well compared to other sectors. Client contracts with Keller-MTS were even higher in 2022 than before the pandemic, confirming the importance of past investments.

In particular, project growth in western Switzerland induced management to invest and expand the Vétroz location. The team at the head office in Regensdorf was also enhanced with new staff.

We intend to continue pursuing our major and minor projects in the well-known Keller quality level and to develop and implement optimised, individual, cost-efficient solutions for our customers. In light of ongoing promising developments in the construction industry, we are looking toward future of Keller-MTS AG Switzerland with optimism. One of our next goals is to recruit new, motivated construction engineers, particularly in the Berne region, to make our presence felt more.

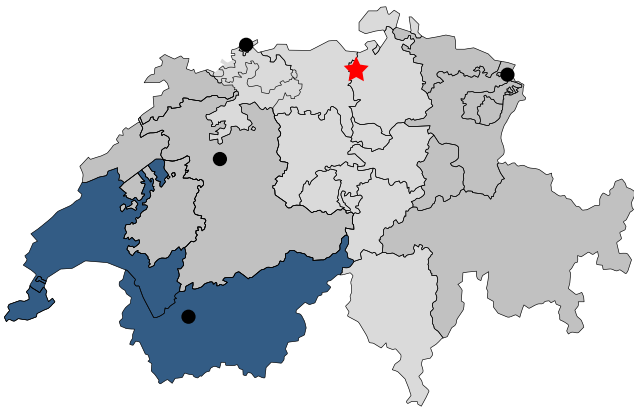

Keller-MTS moved its head office to Regensdorf in 2021, where it operates a yard with integrated workshop in addition to office space. Another workshop and yard for the equipment are located in Vétroz, near Sion, with other branches in Basel, Berne and Rorschacherberg.

In the past year, Keller Switzerland was able to conclude a number of interesting projects, one of which we would like to introduce below:

Renovation of church tower in Steckborn, Switzerland

The tower of the Protestant Church in Steckborn has been tilting for many years now and has been systematically monitored since 2006. During the monitoring period, no abatement of the settlement was identified, making structural renovation necessary. The renovation concept from Keller-MTS, involving the Minifrac technique for stabilisation and an option to straighten the tower again, won the client over and was ultimately implemented.

According to historical documents, the church tower, built in 1833, was built on a foundation of oak piles, which – according to ground analysis – spanned an extremely soft sandy to silty soil layer approx. 2m deep before ending in a loose sandy-gravelly alluvial deposit. The likely cause of the subsidence: a declining groundwater level over many years. As a result, the pile heads were no longer constantly in water, which led to decomposition of the pile heads and thus a reduction of their load-bearing capacity.

To strengthen the tower, 90 injection pipes were added in the indoor and outdoor areas, with three different lengths between 3.5 and 7m, along with inclines beneath the existing quarry-stone foundation.

The subsequent injections with cement grout were performed incrementally and dependent on the constantly observed deformations. The stabilisation works for the existing loose soil layers could be completed when uplifts were detected in the structure.

After a construction period of around nine weeks, the works were concluded successfully.

RENOVATION OF CHURCH TOWER
in Steckborn, Switzerland



HSEQ

service is our success

Our HSEQ department sees itself as a service department for all matters involving health, safety, environment and quality. Our employees are our most valuable asset in every regard. That's why we go to great effort to support them in their everyday work wherever possible, to protect them and increase safety awareness, among other topics.

Elke Legenstein, Martina Rückenbaum – Keller SEN

► One unparalleled campaign that our group initiated was the "Global Safety Week" in May 2022. It enabled us to focus intensively on important topics, specifically accident prevention: reporting near-accidents and/or unsafe situations and conditions. "Near miss" is one of the most important keywords in this area.

But what is a near miss or near accident?

Near misses are potential mistakes and accidents that were discovered in time and therefore remained without consequences. Accordingly, this category involves:

- Unsafe conditions
- Unsafe acts
- Hidden hazards
- Potential risks
- Near misses
- Vulnerabilities
- Unsafe behaviour

In the run-up to the Global Safety Week in May 2022, an HSEQ newsletter was sent to our employees in April 2022 as an announcement of and in preparation for this topic.

HSEQ organised this week with the aim of reinforcing awareness of near misses/unsafe acts/unsafe conditions among employees. To raise awareness of hazards, particularly at construction sites, a poster was created in all SEN languages that depicted the different situations graphically and that contained a QR code to enable incident reporting as quickly as possible.



The QR code can be read by any smartphone or tablet on any construction site and takes the user directly to an online form (also available in all national languages) that queries the most important facts involved in the incident.

Submitter ▶ time ▶ place ▶ product line ▶ equipment involved ▶ description of the incident ▶ potential root causes ▶ corrective measures ▶ noted ideas

This is intended to ensure that employees can submit reports quickly and easily, enabling the HSEQ department to process the incident further.

The reported cases are then processed further by HSEQ. The reasons for this are twofold: First of all, it is important to review the corrective measures and adjust them when needed; secondly, these incidents must be communicated, because it's the only way to avoid repeating the situation at the involved construction site – and at all others, of course.

HSEQ conducts a variety of measures to this end, such as:

- Tool Box Talks (TBT): a prepared, monthly information and training document, which the site managers and foremen present to and discuss with the staff directly at the construction sites

SAFETY WEEK 2022



- Foremen conferences
- Site manager conferences
- Through the continuous improvement process
- And more

An audit concludes the process. During HSEQ construction site audits, special attention is paid to the implementation of the defined corrective measures.

To guarantee the smooth flow of this process, it has been depicted in a flow chart in our IMS system and communicated accordingly.

Motivation mustn't be left by the wayside when it comes to topics like this, however. That's why we nominated a "safety champion" in each country as part of the Global Safety Week and rewarded the initial submissions for the Global Safety Week with small gifts.

KELLER SEN: NEAR MISS/UNSAFE CONDITION/UNSAFE ACT POSTER

THINK SAFE NEAR MISS
UNSAFE CONDITION
UNSAFE ACT

What situations can occur?

<p>UNSAFE CONDITION</p>	<p>UNSAFE ACT</p>
<p>NEAR MISS</p>	<p>INCIDENT</p>

HOW can I report incidents?

- in person / by phone or by phone via MS Teams to the H&S responsible person
- during site inspections
- "Incident report" form in writing or online (MS Forms)

When digitization contributes to construction site safety

Ongoing digitalisation in general and the development of different apps in particular are not only helping us document our construction site processes better, but can also help to improve safety. In the following, we will present two helpful apps as examples.

Christian Sigmund, Reinhard Kulmer – Keller SEN

► The first example of how an app helped us at Keller Grundbau to improve safety at construction sites is the “Duki” app, which is now used to document ductile driven piles at all sites. While this app was primarily developed to support foremen and site managers with the seamless, ongoing documentation of the entire process, after using it for more than two years, it proved to have an incredibly positive effect on building site safety. Why?

Before we rolled out the Duki app, all processes involved in constructing a pile were reported manually by the rig operator. Driving times, driving depths, concrete consumption, pressures and so on had to be timed, read or counted by the rig operator during execution and ultimately written down by hand. All of these steps have now been automated, enabling rig operators to devote 100% of their attention to their activities and their helpers in the swivel range of the excavator.

The second example involves an enhancement to the known “Anchor Inspector” app from Codestruction. The enhance-

ment was made exclusively to increase safety for our workers, however. Following a tragic work accident in early 2021, development on a reliable solution began immediately. We were quickly able to develop a solution to protect our employees better in future. The primary objective was to keep all employees out of the danger zone, to be guaranteed by rolling out dial gauges with Bluetooth connectivity. To ensure that the measured data could be recorded directly during anchor stressing, without manual input, an interface with the dial gauges was programmed.

Under the new work process, no one has to remain in the danger zone during the stressing process any longer. Before the improvement, the measured values (elongation) had to be read directly on the dial gauge next to the stressing jack after every load stage. As a result, employees repeatedly had to enter the danger zone for brief periods, which always posed a potential danger when very high test loads were involved. Thanks to the solution that has now been rolled out, all data is transmitted in real time and processed further in the Anchor Inspector app. This

ensures that employees no longer have to remain in the danger zone during the stressing process.

This enhancement software for the Anchor Inspector app was developed by Keller in a very short time, in cooperation with Codestruction, and can also be used by other companies.

ENHANCEMENT of the stressig app

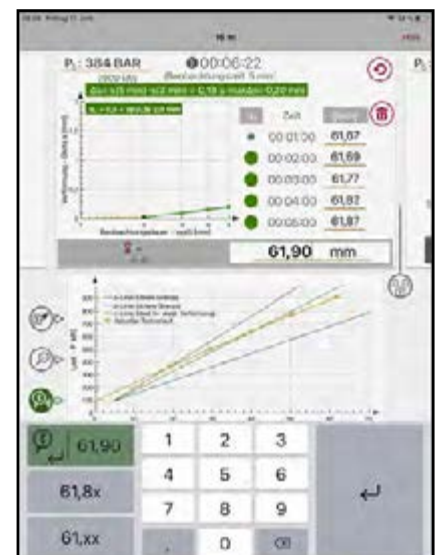



GAUGE WITH BLUETOOTH
transmission to the anchor stressing app

Contact for Codestruction:
Code struction GmbH
Orpheumgasse 15
8020 Graz, Austria

j.stadlbauer@codestruction.eu
www.codestruction.eu

BLUETOOTH GAUGE
for safe transmission





New yard in Věžky, CZ

For proprietary reasons as well as zero perspective for the old yard, KELLER CZ has built a new modern yard with everything the company needs to raise the level of its business. It took a lot of work and money, but the result is definitely perfect.

Petr Svoboda – KELLER
speciální zakládání, Brno

► In 2012, KELLER CZ acquired the old yard in Napajedla through a merger with BORETA. The usable area was 7,500m² and all we had was a roofed wooden building as a temporary warehouse. Unfortunately, nearly 30% of the yard did not belong to us and the D55 highway was going to be built across our land.

We therefore started to intensively look for a new location and in 2019, we managed to acquire a plot of land measuring 10,000m² in the village of Věžky near the D1 highway. It was a neglected and abandoned area on the site of a former agricultural cooperative containing a torso of an old hayloft.

Following the transfer of the property title, in April 2020, we started to clear the area and undertook all the necessary planning and legal actions to obtain demolition and building permits. Having experience with the operation of the old yard, we wanted to create a new facility that would meet the Keller standards (including 5S) and the current needs of the company.

The essential aim was to build a warehouse and/or an assembly (welding) hall. This structure, measuring 14x30m, with a height of 6m, has been assembled from sheet metal panels and designed to protect workers against climatic influences, as well as to accommodate a machine of a certain size, such as a wheeled crane. The structure will also be used to store important materials.

Next to the hall, a set of five office containers and a sanitation container will

be provided to ensure the comfort and convenience of the personnel working there. All necessary utilities, i.e. electricity, water, sewerage, and internet, were brought to the yard. Rainwater is collected in a retention tank, or allowed to seep into the ground surrounding the site. The site is surrounded by an attractive and practical fence with an automatic gate. The surface of the yard is reinforced with recycled asphalt and, wherever necessary, with asphalt concrete. We have already managed to park and store all our machinery, production equipment, tools, and sheet piling there. The site fits into the surrounding industrial environment and does not disturb the character of the village.

Although everything was carefully planned and we tried to contribute by using our own capacities, we are not quite finished yet. We hope that we will soon be able to take pride in our completed modern yard, which will be suitably representative.

What makes us special

Performance and engagement

readiness
challenging
unconventional



Tradition

familiar atmosphere,
reliable partner

Innovation

extraordinary
fascinating
exciting



What we do

Our products

Vibro

Soilcrete® - Jet grouting

Anchors, micropiles,
grouting

Bored piles

Ductile piles

cut-off-walls

DSM

Unsere Lösungen



Who we are

Keller at a glance

1860

founded

10,000

employees

20+

acquisitions
since 2000



5

continents



6,000

projects/year



19

Business units

Building the foundations
for a sustainable future

[linkedin.com/company/keller/](https://www.linkedin.com/company/keller/)

[youtube.com/c/KellerGroup](https://www.youtube.com/c/KellerGroup)

Who we are in SEN

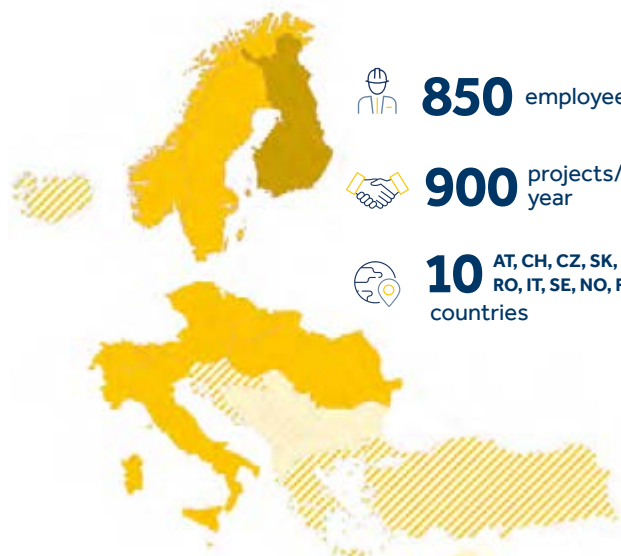

850 employees



900 projects/
year



10 AT, CH, CZ, SK, HU,
RO, IT, SE, NO, FIN
countries



Wagenham substation

“No stone remains unturned” – soil improvement in loose soils with cavities

The Wagenham substation is being built by Austrian Power Grid AG (APG) near Mattighofen. The 380 kV Salzburg line will also be integrated into this. Due to weathering-induced cavities and hardening zones in the subsoil, a multi-stage soil improvement is unavoidable.

Melanie Neumar – Keller Grundbau, Linz

► Surveys of the subsoil in the project region revealed a strongly inhomogeneous picture. The upper section consists of loose to medium dense or soft to stiff decalcified loess. Below this layer are loose to extremely loose gravels and sands from the high terrace deposits. Conglomerate levels are also encountered in this layer. Furthermore, irregularly distributed, weather-induced cavities were also found. This was identified by the surveys and a nearby project carried out ten years ago in Oberkling. The compactness of the ground doesn't increase to medium to very high until the deeper layers, where it is suitable for load transfer.

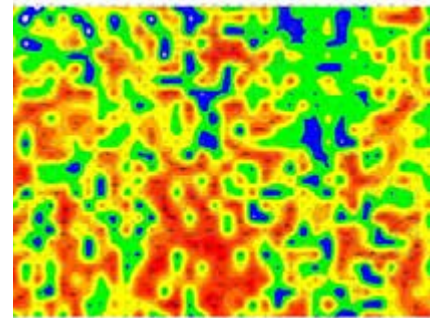

VISUAL ANALYSIS
of the vibro compaction works

Based on the experiences from the reference project, a three-phase concept for the soil improvement was developed.

At the beginning, the loose soil was compacted by adding material to a depth of 15m on the entire construction site using a depth vibrator and water flushing. The vibro compaction (VC) was carried out with a cable dredger, to ensure the safety of staff and equipment in case of settlement of the working platform.

In a second step, the subsoil in the upper zone was improved using vibro replacement in the areas where higher



CABLE DREDGER IN ACTION



PROJECT INFORMATION

Investor:

Austrian Power Grid AG (APG)

Customer:

ARGE APG UW Wagenham
Habau-Felbermayr

Geotechnical consultant:

SKAVA Consulting ZT-GmbH;
GWU Geologie-Wasser-Umwelt GmbH

Quantities:

approx. **65,700m³**
soil improvement with vibro compaction
approx. **1,960m²**
soil improvement with vibro replacement
approx. **1,400m** grouting
approx. **1,210m** bored piles
DN 600

Execution period:

May – August 2022

SUDDEN SETTLEMENT

of the working platform



loads are created by buildings or plant components.

The lower layers that the vibrator could not reach due to hardening zones and conglomerates were improved in the third work step, using cased drillings and cement grouting in the loose sediments.

The visual assessment of the vibro compaction demarcated areas where cement grouting was needed, thus serving as a key instrument for quality assurance.

After a construction time of three months, the works were completed successfully and handed over to the client.

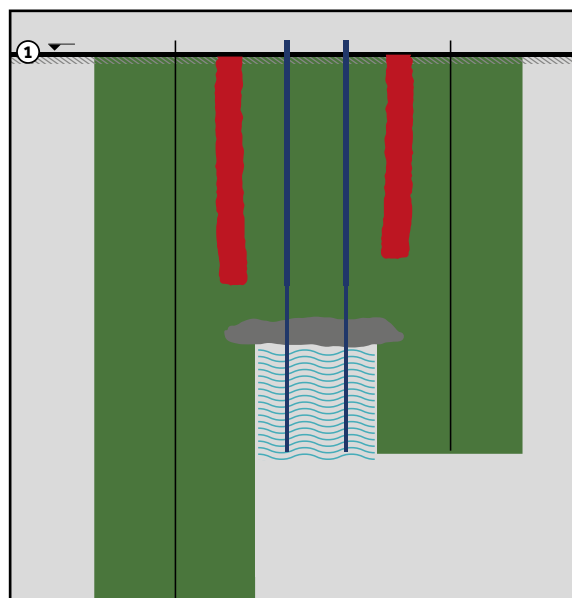

- grouting
- vibro replacement
- vibro compaction
- conglomerates
- ① excavation slab



Vienna underground – U2xU5 line crossing **Precision work with millimetre tolerances**

Anyone who takes a stroll through the Vienna city centre will immediately notice that there seems to be construction all over the place. Vienna's steadily growing population and the ecological significance of the public transportation network are the key reasons why construction works for the new U5 underground line and extension of the U2 underground line are in full swing.

Wolfgang Hasenöhrl – Keller Grundbau, Wien

► Keller Grundbau has been carrying out a number of special foundation works since mid-2021 for the construction lots "U2/22 Rathaus" (city hall) and "U5/2 Frankhplatz". Some of these measures involve compensation grouting. Settlements resulting from the tunnel excavation are being compensated by Keller n using the Soilfrac® technique.

Culturally significant buildings that are in the projected settlement area of the new U2xU5 line crossing are being protected from negative impacts (such as increased settlements) to the extent possible. In the first step, a shaft drilling rig is being used to install the sleeve pipes below the buildings (sleeves = openings in the steel pipe every 50cm). A double packer is then inserted down to the required depth and over the opening in the sleeve pipe suspension grout is grouted. Flow paths (fracs) will open in the soil,



PLACEMENT OF THE DOUBLE PACKERS

PROJECT INFORMATION

Investor:

Wiener Linien GmbH & CoKG

Customer:

Arge U2/22xU5/
Rathaus/Frankplatz
(Swietelsky-Habau-Hochtief)

Geotechnical consultant:

MA29 – Bridge Construction and
Foundation Engineering

Design:

Arge Planer U5/2 (ISP, SCZ, Tecton)
Arge Planer U2/22
(IGT, Potyka & Partner, ste.p ZT)

Quantities:

Compensation grouting
(Soilfrac®)

Execution period:

2022 – 2024

GRAPHIC:

3D model of our works

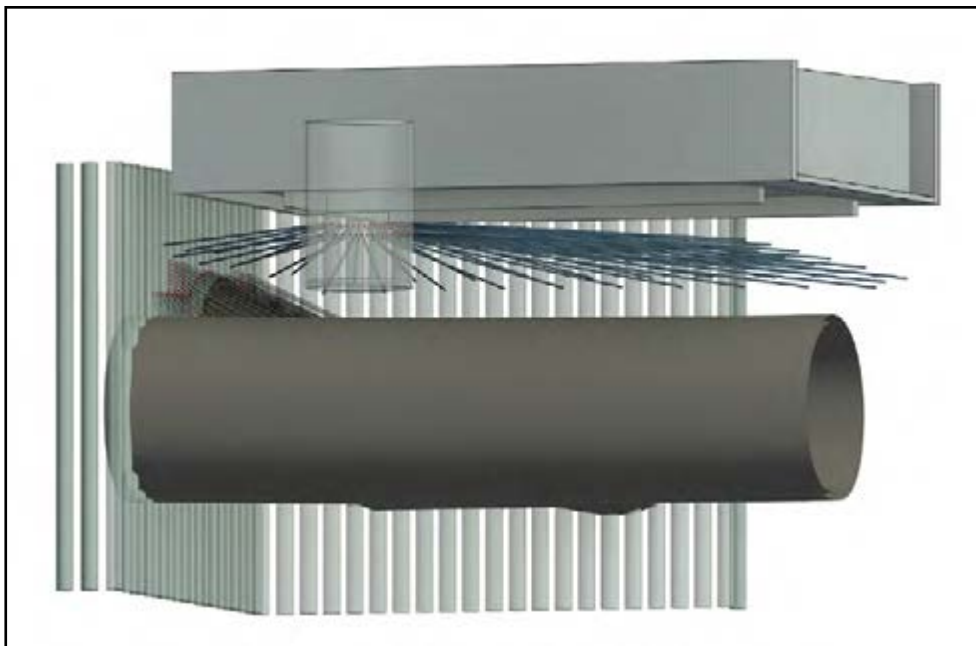

fracks into which the cement grout can penetrate and harden. Multiple application of this injection process makes it possible to compensate for settlements and create uplift. Deformation monitoring of the existing buildings provides the basis for the timely, targeted control of the injection processes with accuracy up to 1/10th of a millimetre. Around 7,000m of sleeve pipes are being installed by Keller Grundbau for this purpose, over a total compensation area of around 7,800m² (five areas).

The compensation fields are currently being prepared for the tunnel excavation through anticipatory initial injections.



Alleviation of the traffic situation in Golling ÖBB Golling line improvement

The Ramsstraße railway underpass in the heart of Golling, as well as the railway crossing in the Wasserfallstraße, are no longer able to handle the current traffic volume and are being replaced by modern underpasses. The local geology and groundwater situation required watertight construction pits.

Dominik Struber – Keller Grundbau, Salzburg (Eben im Pongau)

► As part of the line improvements for ÖBB, the Austrian national railway, improvements were also made to the traffic infrastructure in the centre of Golling an der Salzach. The works we carried out can be divided roughly into three areas: replacement of the existing Ramsstraße underpass in the south, construction of the new Wasserfallstraße underpass and a retaining wall between them

Ramsstraße underpass:

The construction pit here was planned using a sheet pile wall that was stiffened in the bottom area. The stiffening layer and sealing against the groundwater were implemented with a high-level jet grouting slab with thicknesses between 2 and 2.5m. It was executed with column diameters of up to 3m and secured downwards using uplift micropiles with lengths of up to 14m. In addition to an efficient jet geometry for the slab, the JG backflow was handled by a treatment plan to reduce the disposal volumes. Afterwards, the uplift micropiles were placed for the parts of the slab that are not located below the railway bed.

After the outer reinforced concrete tank was installed, the temporary abutments for the provisional bridge were secured

by strand anchors beneath the railway line – which was active during construction; the JG was then executed under a restricted ceiling height (only 2.3m) and the necessary uplift micropiles for this part of the slab were also installed.

In mid-April 2021, all works on the excavation pit were completed and the final excavation beneath the railway line was carried out. The underpass was commissioned in early August 2021, after a construction time of less than a year.

Line improvement between the underpasses:

To enable the trains to travel faster, the route of the railway line was improved in the area between the two underpasses. To execute these improvements to the existing railway embankment, the jet-grouting works were carried out in parallel to the works on the Ramsstraße underpass. The existing railway embankment was secured with a 4m-high shotcrete wall with a thickness of 15cm. Soil nailing was executed additionally to connect the shotcrete wall with the existing railway embankment.

Wasserfallstraße underpass:

The JG execution design for this underpass proved to be much



PROJECT INFORMATION

Investor:

ÖBB Infrastruktur AG

Customer:

Ing. Hans Bodner
Baugesellschaft mbH & Co KG

Geotechnical consultant:

BGG Consult ZT GmbH

Design:

BGG Consult ZT GmbH

Quantities:

5,700m³ jet grouting slab

1,300m uplift micropiles DN200

600m temporary strand anchors

310m² shotcrete and soil nails

Execution period:

October 2020 – May 2022

JET GROUTING WORKS AT THE RAMSLSTRASSE

Jet grouting works at the Ramsstraße

more complicated than the Ramsstraße underpass. In addition to a three-dimensionally inclined, high-level JG slab, a ramp of this underpass turns 180 degrees downwards in the curve radius. In addition, retaining walls, consisting of sheet piles and DN90 cm large bored piles had to be taken into account. Another complication was that the works could not be carried out in one go due to local factors involving building development and traffic routing. For this construction pit, JG columns with

POSITION AND TYPE

of Keller works



- ① underpass Wasserfall
- shotcrete wall
- ② underpass Ramsl

diameters of up to 3m were used, analogous to the previous Ramsstraße. The slab thickness decreases here, from 2.5m in the deep part to up to 1m in the shallow areas. The uplift micropiles required drilling depths of up to 21m.

After the JG works below the railway around Ramsstraße were completed, work on the first JG section within the curve radius began in the spring of 2021. After the road through the construction field was relocated, the area around the street bridge and slide-in excavation pit for the ÖBB bridge construction was executed, including the uplift micropiles and strand anchors. After further preparation of the construction site, the remaining part of the curve radius and opposite ramp were produced in the spring of 2022. Similar to the works around the Ramsstraße underpass, the construction pit beneath the active ÖBB line was executed during the ongoing concreting works for the slide-in bridge, starting with the strand anchors alongside the rail line and continuing with the installation of the JG slab and the necessary uplift micropiles. Here, too, a variety of measures were used to minimise the backflow.

Despite the geologically demanding soil conditions, we were able to complete our works on schedule and to the full satisfaction of everyone involved in the project.

Zirkusgasse 46-48

Bundesreal- gymnasium Wien II

In the heart of Vienna's 2nd district, close to the Prater, the Zirkusgasse 46-48 Gymnasium is being renovated and expanded through 2023. As part of the works, an underground gym is being built in the courtyard area. Keller Grundbau has been commissioned to carry out the excavation pit support works as part of a consortium.

Thomas Dolesch, Christoph Nagl – Keller Grundbau, Wien

► The Bundesrealgymnasium Wien II, Zirkusgasse 46-48 in 1020 Vienna, has been renovated and expanded. To enable construction of a new, underground gym, the existing courtyard was demolished and a 10m deep construction pit was established. Keller Grundbau was commissioned to implement the construction pit support as part of the "Spezialtiefbau Keller – Granit" consortium.

Since the slab of the excavation pit was six metres below the groundwater level, it had to be made watertight. To achieve this, a contiguous bored pile wall was selected, with the jet-grouting process (JG) used to seal the gaps between the bored piles. In addition, the existing building had to be underpinned using the jet-grouting columns, to create an underground connection with the new building.

Due to the depth of the excavation pit and the adjacent buildings, the excavation pit had to be executed top-down. As a consequence, all of the excavated material had to be removed underground, through two openings in the concrete slab. A majority of the JG works had to be performed with small rigs in the interior of the existing building under confined space conditions.

Overall, around 1,400m of bored piles were executed, up to 25m deep, with a variety of diameters up to 120cm, as well as 1,400m³ of JG elements and 80 JG gaps with depths of up to 18m. Most of the JG works was performed with a small rig in the interior of the existing building.

The construction site was very confined due its urban location, making it difficult to work with large rigs. The tight construction schedule made it necessary to use two bored pile rigs and one JG system in parallel at times, resulting in new challenges at the complex building site.

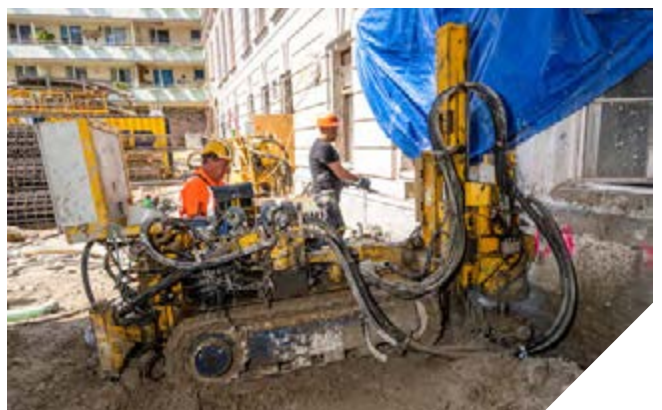



The use of a novel decanter system proved to be very advantageous: the JG backflow could be treated, reducing the backflow volume that had to be disposed of to its solid components. In turn, this resulted in a significant reduction in CO₂ emissions, since it reduced the number of truck trips required for disposal, which also reduced the traffic impact on local residents.

PROJECT INFORMATION

Investor:

BIG Bundeimmobiliengesellschaft m.b.H.

Customer:

BIG Bundeimmobiliengesellschaft m.b.H.

Geotechnical consultant:

Blovsky Geotechnik ZT GmbH

Design/ pit support:

Keller Grundbau GmbH

Techniques:

Jet grouting, Bored piles

Execution period:

April – July 2022

USE OF THE CENTRIFUGE

to minimise the amount of backflow of grout that must be land-filled



S7 Fürstenfelder Schnellstraße

East section – construction lot 03

To relieve through traffic in the greater Fürstenfeld area, the new Fürstenfelder Schnellstraße (Fürstenfeld highway) has been under construction since 2017, from the Riegersdorf interchange junction (A2) to the national border near Heiligenkreuz. Keller has been commissioned to carry out special foundation works in several sections since the beginning of the project and has contributed to four construction lots since 2019.

Peter Schicker – Keller Grundbau, Söding

► In early 2022, the fifth and latest contract was awarded to us by the company Massivbau GmbH for special foundation works in construction lot 03 East. This construction lot involves a section around 7.8km long between the towns of Dobersdorf and Königsdorf in Burgenland and includes all earthworks and road construction measures, as well as the erection of several structures. Five of these structures require us to execute foundation and protection measures: specifically three bridges (S7.28, S7.30 and S7.35) and two retaining walls (S7.30a and S7.35a).

Due to severe geological conditions, the bridge objects are founded on DM90 bored piles. Each object requires nine to twelve piles, each with individual lengths of up to 13m, using the CFA technique. The two retaining walls (Königsdorf 1 steep face – 149 piles and Königsdorf 2 steep face – 261 piles), require also CFA piles with a drilling depth of up to 19m.

The two intermittent retaining pile walls, with lengths of 275m and 460m respectively, will be anchored in the head beam with permanent anchors due to the approx. 6m overhang. Lagging will be executed with shotcrete by our client.

In accordance with the overall schedule, our work will be executed in two phases each. During the first phase in April/May 2022, the piles for the two bridge objects S7.28 and S7.30 and for the Königsdorf 1 steep face were executed. Once the pile heads have been prepared and the construction of the head beam for S7.30a, the permanent anchors – with up to five strands and up to 26m in length – will be executed.

ALREADY EXECUTED PILES (S7.30A)





PROJECT INFORMATION

Investor:

ASFINAG Bau Management GmbH

Customer:

Massivbau GmbH

Geotechnical consultant:

BGG Consult

Design:

Wörle Sparowitz Ingenieure /
Kratzer ZT GmbH

Quantities:

~5,300m bored piles

~4,960m permanent anchors

Execution period:

April 2022 – spring 2023

Phase two which comprises execution of piles for the remaining bridge S7.35 and the Königsdorf 2 steep face, took place shortly before the end of the year. The final phase to execute the permanent anchors for the S7.35a steep face, is planned for the spring of 2023.

Due to the great drilling depths, only large drill rigs (BG30H and BG36H) could be used. The exhaust emissions had to be taken into account in the rig selection due to the strict nature conservation and emission requirements for the overall construction lot. The greatest challenge here is that all diesel-fuelled rigs must be equipped with a particle filter system. This required early planning, because not all rigs meet these requirements.

Thanks to the quite good soil conditions and generous spatial conditions, as well as the always on-time preliminary work carried out by our client, all of our works have been carried out to date to the fullest satisfaction of everyone involved.

EXECUTION OF THE CFA PILES

with a BG30H



Cut-and-cover tunnels in Scheffau and Prutz

As part of its package of pandemic-related measures, the State of Tyrol moved up two major infrastructure projects that will help to relieve traffic on the B178 Loferer Straße and the B180 Reschenstraße.

Hansjörg Haller, Devid Wolfsgruber – Keller Grundbau, Innsbruck



B178 SCHEFFAU
am Wilden Kaiser

► Cut-and-cover tunnel in Scheffau:

The B178 Loferer Straße is one of the most important supra-regional transport connections in the Tyrol state road network. In the section between road km 13.90 and km 16.20, the B178 crosses the municipality of Scheffau am Wilden Kaiser. Due to its supra-regional character and inflow from the B173 Eibergstraße, the B178 Loferer Straße has high annual average daily traffic of around 19,628 cars/24h. On the initiative of the state road administration and the municipality of Scheffau am Wilden Kaiser, the road application planning began for an environmentally friendly redesign in the municipality of Scheffau am Wilden Kaiser.

The tunnel was constructed using the cut-and-cover method. To enable this, Keller was commissioned to implement the lateral pit support.



Due to the tight spatial conditions, the varying soil conditions (stony, block-like, gravelly, sandy) and groundwater involved, a DN120 bored pile wall was constructed with jet grouting lagging.

Struts were installed in sections during the excavation works.

Additional sealing and transverse bulkheads were constructed using the jet grouting method at the transitions between the seven construction phases.

The maximum drilling depth for the bored piles and JG is 24m from the existing ground level.

A Liebherr LH8070 cable dredger and a BG36 were chosen to execute the bored piles. A Keller rig (KB6) was used to create the JG gaps.

Only continual coordination with the main contractor and the client makes it possible to keep the complex construction process and the logistics around the building site running smoothly.



KELLER WORKS IN PRUTZ



Reschenstraße Prutz:

Special foundation works along Reschenstraße near Prutz started in October 2021. The underpass, which is around 800m long, is also being built using the cut-and-cover method. To protect the construction pit, which has a depth of up to nine metres, bored piles (DN120 and DN90) are executed up to 20m in depth and with JG lagging. In the deepest part of the underpass, the piles will be secured by pre-stressed strand anchors. Since the structure lies largely in the groundwater and the soil is described as highly permeable (gravel, sand, stone), a deep-set JG sealing slab was executed. Permanent micropiles will be produced for uplift control of the tank construction.

The top priority during the execution of the special foundation works is maintaining ongoing traffic, a factor that shouldn't be underestimated with a traffic load of around 25,000 vehicles per day. During the first traffic phase, bored piles and JG gaps were installed along a strip some seven metres wide between Reschenstraße and the Inn river.

Once all the special foundation works were completed on the west side in March 2022, Reschenstraße was shifted along the entire length of the underpass, enabling the works on the east side of the underpass and the sealing slab to be produced starting in May.

GRAPHIC

cross section of Reschenstraße Prutz

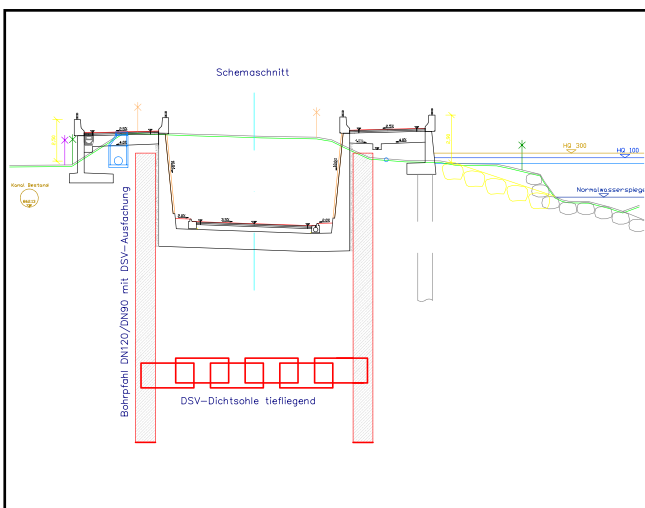



PROJECT INFORMATION

Investor:

Bregenzer Festspiele GmbH

Customer:

Bregenzer Festspiele

Geotechnical consultant:

Andres Geotechnik AG

Quantities:

8 micropiles

Execution period:

October – November 2021

Bregenz lake stage Keller becomes part of the 2022 Bregenz Festival

The acclaimed opera "Madame Butterfly" by Giacomo Puccini could be seen at the lake stage for the first time in 2022. The current stage set required tension micropiles at the bottom of Lake Constance to protect it against washing of the waves and buoyancy.

Gerhard Meyer, Andreas Neyer –
Keller Grundbau, Dornbirn

► Back in 2019, Keller Grundbau received a request to install eight micropiles for the new stage set and was awarded with this work in March of 2020.

The outbreak of the Covid pandemic in Austria in the spring of 2020 prevented execution of the stage for Madame Butterfly, which was planned for the autumn of 2020. But by the autumn of 2021, the time had finally come. The new stage set symbolises a sheet of paper and consists of a polystyrene surface built on a structure of wood and steel. This struc-

ture needs to withstand storms on Lake Constance. The set is 23m high and 33m wide. The lowest part of the stage set can be immersed in Lake Constance, depending on the water level, and is therefore subject to wave washing and uplift. To withstand the resulting tensile forces, eight micropiles were drilled into the lake bottom. These piles transfer loads up to 400 kN of pressure and tension into the ground. The client expressed its special interest in the serviceability of the piles and a lifespan of at least 25 years for the micropiles, as well as the water protection required by the authorities.

The works began in the autumn, at a water depth of around two metres. A Klemm 806-3D drilling rig with oscillating rotary head was shipped to the industrial harbour of Hard and then operated on site. An additional pontoon served as the working platform. After measurement via GPS, the bores were sunk and a GEWI DN 63 pile with double corrosion protection was installed with an additional steel protective tube on the upper eight metres. Post grouting at different depths was executed to increase the load transfer behaviour of the micropiles. The galvanised upper end of the piles

is connected with special anchor plates to the steel structure. The assembly and inspection of the head structure, which is exposed to water, were carried out by industrial divers. A static load test was carried out to verify the designed pile force. In addition to working on water and exercising the necessary caution for handling cement grout in a freshwater lake, positioning the drilling rig and holding these positions proved to be a special challenge. Although the working vessel was supported on the lake floor, stronger waves made it difficult to keep it in the correct position.

Despite all difficulties, the micropiles were handed over to the clients as agreed after around two weeks.

As a result, nothing else stood in the way of a successful performance in the summer of 2022.

EXECUTION OF THE MICROPILES (offshore)





PROJECT INFORMATION

Investor:

KM5 Immobilien GmbH

Customer:

Zimmermann Bau

Geotechnical consultant:

3P Geotechnik Wes

Design:

M+G Ingenieure ZT

Technique:

Jet grouting

Execution period:

April – May 2022

KM 5 Bregenz

History meets modernity

A hotel is being built on Kornmarktplatz in Bregenz. The old façade will be remained intact. The immediate proximity to Lake Constance and the urban situation made the production of an excavation pit support a particular challenge.

Gerhard Meyer, Lukas Waldhart – Keller Grundbau, Dornbirn

▶ A hotel is being built directly on Kornmarktplatz, the former 17th-century trading venue, opposite the Vorarlberg state museum and around 200m away from Lake Constance. After demolition of the old structures, the existing façade fronts a gap that is eight meters wide and 22m deep. The lower level of the building will be approx. 5.4m below ground level. Neighbouring construction and a groundwater level of 1.9m below ground made it necessary to build an excavation pit supported by jet grouting columns.

To meet the static requirements, earth and water pressure and hydraulic pressure on the slab, as well as guarantee the impermeability of the excavation pit, Keller developed an alternative design concept and presented it to the client.

In this concept, the construction pit would be enclosed with a JG wall up to a depth of around 12.5m. This met the requirements for impermeability and hydraulic ground seepage. To simplify the excavation work and subsequent production of the basement walls, stiffening jet grouting bodies were executed immediately beneath the excavation base, instead of using two temporary steel struts as was designed in the original concept. In the second step, DN 150 mm steel pipes with a distance of 0.4 to 0.8m were drilled into the JG wall down to a depth of eight metres.

Temporary steel girders of HEB 260 placed above the basement walls completed the strutting of the excavation pit in combination with the steel pipes and foundation bars.

This concept simplified excavation works and execution of the basement floor.

The confined space conditions presented a special challenge. In particular, the open market that takes place twice a week had to be taken into account. The soil conditions (lacustrine clays) required

extensive additional measures for the jet-grouting work (such as pre-cutting). A centrifuge was used to dewater the backflow, resulting in significant reductions of backflow volume. The centrifuged water was neutralised with a CO₂ system, which meant it could be fed into the city sewers without problems.

JET GROUTING WORKS

under confined space conditions



A14 AST

Rheintal Mitte

To relieve the existing motorway connection and connect the Dornbirn Wallenmahd industrial and business park, the Rheintal Mitte (later Dornbirn Süd) connection was built. The prevailing soil conditions in the Rhine Valley required extensive soil improvement works.

Gerhard Meyer – Keller Grundbau, Dornbirn



► The A14 runs from the connection to the S16 Arlberg highway through Walgau and the Vorarlberg Rhine Valley, from south-east to north, and joins the German autobahn network after the Pfänder Tunnel.

Many industrial and business enterprises have been established at the northern and southern borders around Dornbirn in particular in the last 20 years. The “Wallenmahd” business park in the south did not have a connection to the A14 until early this year. Goods could only be transported via the highly frequented former connection Dornbirn Süd (now Dornbirn West) or via the Hohenems connection further to the south, which resulted in constant overloads of these two traffic junctions over the years – not least because these two autobahn connections also handle a majority of commuter and shopping traffic (Messepark and Messe Dornbirn) between Switzerland and Vorarlberg.

In 2006, the Vorarlberg state government and the three affected municipalities Dornbirn, Hohenems and Lustenau began a process aimed at improving this situation. Ultimately, they decided to build a new, full connection between Dornbirn and Hohenems.

The project area is located directly in the Vorarlberg Rhine Valley, within the city limits of Dornbirn, Vorarlberg’s largest city.

The Vorarlberg Rhine Valley is well known for its poor soil conditions.

The load-bearing sand layers only are located at depths from around 15–21m. The soil layers above them consist of alternating mixtures of silts, peats and clays, as well as pure peat and sand layers.

These types of soils are very sensitive to settlements. Without special treatment, the entrance and exit ramps would settle over the decades, resulting in significantly higher maintenance expenses to preserve the roads and expansion joints.

In 2020, ASFINAG executed extensive preload fillings in the area of the future entrance and exit ramps.

In addition, a test field was set out between the ramp areas, from which several vibro stone columns were executed. To bridge the particularly soft soil layers, these columns were mortared with cement grout in different layers. The advantage

CROSS SECTION

of the vibro stone columns test field

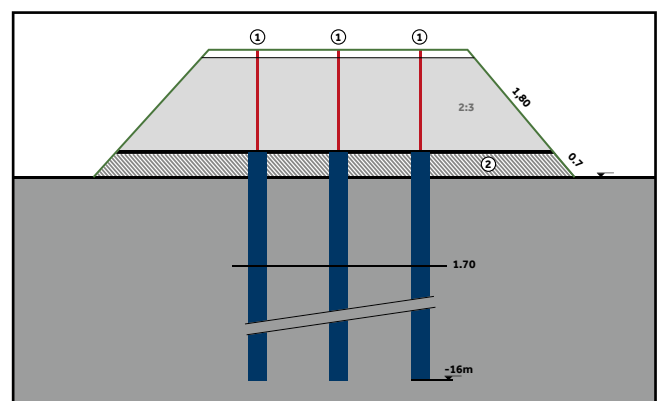

- ① settlement level
- ② working platform
- preload fillings
- composite geotextile
- vibro replacement DN 50cm



WORKS VERY CLOSE TO THE HIGHWAY

of this kind of soil improvement is that there is no stiff transition to the existing roads, despite a large reduction in settlement behaviour. This reduces the risk of bigger settlement differences between the existing and new roadways.

Subsidence levels were placed above the head of the test columns and a preload filling was placed. After several months of observation by the commissioned geotechnics expert, the behaviour of the partially grouted stone columns was defined and tendered by the client

In April 2021, the Rheintal Mitte consortium – consisting of I+R Bau GmbH, Tomaselli Gabriel Bau GmbH and Rhomberg Bau GmbH awarded Keller to carry out the vibro replacement works. To meet the ambitious schedule, the deployment of up to three Keller rigs was planned. Optimisations defined during execution planning resulted in a reduction of the quantities and cost savings for the client. As a result, the use of two large rigs was sufficient to meet the defined construction schedule.

Keller began the works in April 2021 and completed them by late June 2021, in accordance with the agreed schedule.

Overall, Keller Grundbau executed 895 partially grouted stone columns with a total length of around 17,000m.

The new connection was opened to traffic in late February 2022 and was renamed “Dornbirn Süd” at the same time.

THE USED TR07

is currently Keller’s largest vibro unit.



Drilled piles for the new Engeløya Bridge

A project up in the North

For the new bridge between the Engeløya island and Bogen, Keller Geoteknikk is executing all geotechnical works for the foundation. Therefore, Reverse Circulation Drilling is used for all 84 piles with around 2,000m pile length. Keller also executed soil and rock investigations prior to the start of the works to verify the bedrock level and quality assumed in the design stage.

Wojciech Szczepinski – Keller Geoteknikk, Oslo

► For the new bridge between the Engeløya island and Bogen, Keller Geoteknikk is executing all geotechnical works for the foundation. Therefore, Reverse Circulation Drilling is used for all 84 piles with around 2,000m pile length. Keller also executed soil and rock investigations prior to the start of the works to verify the bedrock level and quality assumed in the design stage.

The Engeløya Bridge project consists of a 320m long concrete bridge and 600m new access road constructed by land reclamation. The existing one-lane bridge, built in 1978, will be demolished after the new double-lane, the pre-stressed concrete bridge, is completed. Due to severe corrosion problems on the existing bridge, the Norwegian road authorities decided to construct a new bridge which has to be operational within 2024.

Implenia Norge AS, in cooperation with Keller Geoteknikk AS, submitted the best offer regarding quality, time schedule and price. This partnership started early in the tender phase due to Keller's leading position in the Norwegian market with Reverse Circulation Drilling. Besides the challenging weather conditions in the Lofoten area, we faced other limitations for the execution of physical works in the sea during the year, e.g. no drilling was allowed from February to May to protect the local fish species.



The foundation works were divided into nine axes to be drilled from the sea and two from land. All drilling works had to be done by Reverse Circulation Drilling to minimise the impact on the surrounding soil. Furthermore, all piles were designed as end-bearing piles and had to be drilled two metres into sound bedrock.

In January 2022, Keller executed an investigation campaign to determine the quality and depth of the bedrock. We took samples from the seabed sediments as well as from the bedrock. These investigations allowed to order all permanent casings in full length. By doing this, we ensured the high-quality requirements for the steel pipes. The 1016mm x 14.2mm steel casings were drilled to a depth of up to 33m with inclinations of 7° and 14°.

One axis consists of eight piles, connected in the pile cap going over into the concreted pillars of the bridge. The concrete bridge, placed between the pillars, is designed as a pre-stressed concrete structure. The nine axes, executed from two barges, were supplied with all necessary materials from a service boat capable of transporting piles up to 33m. Inclined bedrock on one axis led to higher than the allowed project specifications. Therefore, we executed underwater blasting works to flatten the rock surface and to ensure the pile installation was within the limits of the contract.

AXIS OF EIGHT PILES





PROJECT INFORMATION

Investor:

Nordlands Flykeskommune

Customer:

Implenia Norge AS

Geotechnical consultant:

Efla AS

Quantities:

84 piles (Reverse-Circulation-process); soil and rock investigations

Execution period:

May – December 2022

VIEW ON THE AXES CONSISTING

of eight piles each

Besides the drilling works, we also installed the temporary bracing of the piles. As the location in northern Norway shows a tidal difference of three metres, the bracing installation close to the lowest water level was an additional challenge and limited to two windows of one and a half hours during one full day. This circumstance, in combination with high winds, waves and rain, forced the site team to work day and night shifts for this installation process.

In parallel, all piles had to be sealed to the bedrock, which required injection works to reach the given Lugeon criteria of 0.5.

Afterwards, the piles had to be re-drilled to sound bedrock before cleaning the pile foot. All piles were inspected using an underwater camera before installing the reinforcement cage to prove the clean and debris-free pile foot. Only a maximum of two hours was allowed between reinforcement cage installation and the start of the concrete works. The piles were concreted using tremie pipes and a concrete mix with special anti-washout additives. The quality control for the concreted piles had to be done by core drilling and cross-hole sonic logging. Three pipes attached to the reinforcement cage had to be used to investigate the bedrock-concrete connection of the piles. Before the core drilling, we had to use cross-hole sonic logging to ensure the integrity of the concrete over the whole pile length.

Dedicated people at the site managed this challenging project and showed that Keller Geoteknikk AS is a reliable partner to execute such remote projects to the highest level of quality.

We are looking forward to the opening of the new bridge in 2024.

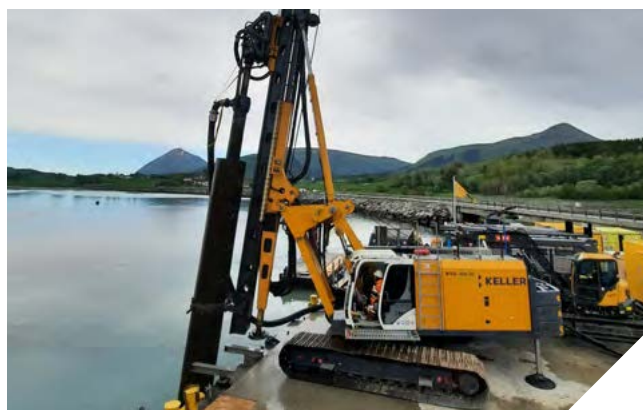

KELLER'S OFFSHORE WORKS



Test field 'Kolkajen' in Stockholm

Yes, you can use 'wet soil mixing' in the water

'Kolkajen Living Area' is one of the multiple projects of the City of Stockholm to build residential areas for the increasing population of Sweden's capital. Thanks to the global reach of Keller, the Swedish branch was supported by Keller Polska.

Fredrik Brauer – Keller Grundläggning, Stockholm

► 'Kolkajen Living Area' is one of the multiple projects of the City of Stockholm to build residential areas for the increasing population of Sweden's capital. Thanks to the global reach of Keller, the Swedish branch was supported by Keller Polska.

As unoccupied spaces in Stockholm become scarcer, older abandoned industrial areas are also being reused for new living zones. But even that is not always enough. So, planners of the residential area 'Kolkajen' decided to expand into Stockholm's water. Stockholm Royal Seaport is one of the largest urban development areas in Sweden with at least 12,000 new apartments and 35,000 workplaces.

'Kolkajen' is one of the larger sub-projects in the area with 1,500 apartments and about 10,000m² commercial space. To make the expansion in the water possible, they developed a draft design to stabilise the lake bed down to the moraine layer with 10m to 20m cement pillars in 10m water depth. Whether the project was to be executed by a 'wet' or 'dry' method would be determined after making the test columns.

Peab Anläggning AB, one of the largest construction companies in Sweden, had a contract with the City of Stockholm. Keller had the opportunity to leave an offer on the execution of the test columns. Although the Scandinavian region is dominated by 'dry soil mixing', we offered to perform a test-field using 'wet soil mixing', with the insight of our Polish colleagues. This method is the more beneficial and environmentally friendly solution of soil stabilisation in 10m water depth. The fact that we could produce 2.4m instead of 2.0m diameter

columns also felt like a better and smarter solution. The time for the execution was limited to March since it is forbidden to carry out work in the water from April to August.

Our solution with wet soil mixing' and a column diameter of 2.4m was presented together with our tender for Peab Anläggning AB, the City of Stockholm and Geomind. After a couple of meetings, we got the information in February 2022 that we won the project to execute these test columns.

The planning for the production started immediately after winning the project. To get the machines and equipment mobilised at the beginning of March and start production. Keller Poland and Sweden made a huge effort to make things work, and Peab Anläggning AB loaded the rig on the barge at the beginning of March and site installation and technical preparation was set up.

We executed the first test column in the mid of March and had continuous work until the end of the month – except for Sundays. At the last minute, the client added one more column, and the team was still able to execute all the columns and the associated test to be done and finish the project on time. The deadline was for 31 March 2022. After completing the project, the team started to de-mobilise all the equipment and the machine, and in the first week of April, the last equipment left the construction site before the team flew back to Poland.

The biggest challenge was getting the barge to lie completely still as the test piles were carried out from a pontoon barge





instead of a Jack-up barge. A rig of almost 130 tons with its forces at work and with winds and waves as external influences, made this a challenge for all of us. Additional problems were rock blocks in one section of the test field. But due to good communication among all involved parties, we were able to move these to new locations and finish all the requested work in time.

I would like to take the opportunity to thank all the personnel involved in this project from both countries. You all did a GREAT job, and I am happy to see that our motto 'global strength and local focus' is really what defines Keller.

The project included:

- 37 columns \varnothing 2.4m with an average stabilised length of 15m and water depth of 10m
- 12 executions of wet grab – five per column
- Suspension tests (strength)

Machine and equipment:

- LRB 355 provided by Keller Polska
- TWG 35 pump by Keller Polska
- Batch plant provided by Keller Geoteknikk
- Barge and other equipment for works on the water by Peab Anläggning AB

Geotechnics:

- The seabed was pre-excavated and a layer of 0/63 filling material in 1m height was built up by Peab
- ~10m water
- ~5m mud
- ~10–15m clay
- Friction soil

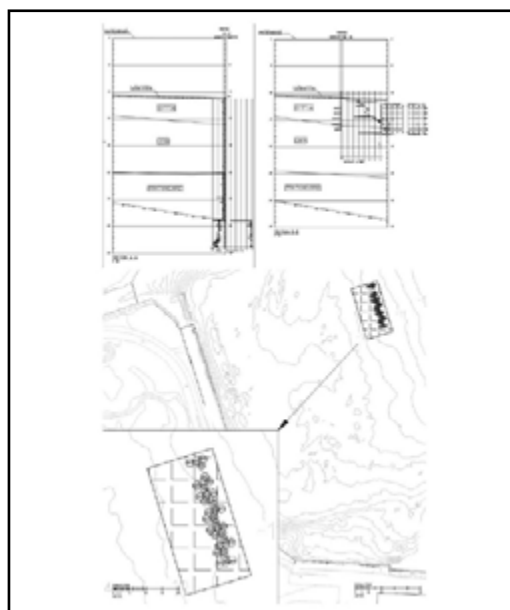

Keller Ductile Piles for Sustainable Food Production

Known as the 'Land of Fire and Ice', it's no wonder that Iceland is a pioneer and global leader in generating clean geothermal energy for electricity and heating. But when an Icelandic company decided to use the natural outputs of the Hellisheiði power plant to convert clean energy into sustainable food, Keller was on site to lay the foundations for it.

Muhamed Mesic – Keller SEN

► In May 2022, Keller returned to Iceland for another project with Keller Ductile Piles (KDP). Since its introduction into the Icelandic market in 2017, KDP has established itself as an attractive foundation solution for a variety of uses in Iceland. For our first project outside the direct area of Iceland's capital city of Reykjavik, Keller worked in close cooperation with designers Mannvit and executed approx. 1,800m of KDP ductile steel piles (approx. 340 pcs) at the site of the Hellisheiði geothermal power plant in Ölfus municipality, in South Iceland. Static pile load testing was carried out on site to ensure the expected bearing capacity of 750kN was achieved.

The only thing more unique than the backdrop of the project – right next to one of the world's largest geothermal power plants – was the project facility, providing a unique aspect to Keller's approach to sustainability.

The client, VAXA Technologies Iceland ehf., is a young Icelandic company of technology and biology experts currently extending facility integrated with the Hellisheiði power plant, that transforms the waste outputs of the power plant into sustainable resources for microalgae production. Using clean energy from the power plant, VAXA has a technology platform that uses photobioreactors to enable year-round production



PRODUCTION OF MICROALGAE
by VAXA

of pathogen-free, carbon negative algae, requiring less than 1% of the fresh water and land footprint compared to industry standards. There are no herbicides or pesticides needed, and no waste produced to contaminate the environment.

In these uncertain times where almost 800 million people around the world face hunger, an uncertainty driven by conflict, climate variability and economic challenges, microalgae could be an excellent and sustainable alternative food source. Microalgae is rich in protein, and unlike other plant-based sources such as soy, it contains a complete essential amino acid profile and is rich with phyco-nutrients. VAXA – meaning 'grow' in Icelandic – has been operational since 2019, starting with growing nutrients for fish in aquaculture which replace unsustainable fishmeal. The new plant being built on Keller foundations shall enable the production of nutrients for humans, including vegan and vegetarian friendly protein drop-ins, natural food colorants, and nutritional supplements.

Keller is proud to have provided the foundations for turning this groundbreaking scientific approach to food production into reality. It marks not just another successful return for KDP to the Icelandic market, but our contribution to a groundbreaking approach to tomorrow's nutrition.

Samsung relies on Keller

Keller Mélyépítő, our Hungarian company, had the chance to execute some very interesting projects for the South-Korean company, of which we would like to show one – the Samsung SDI project in Göd. Here, for the extension of the already existing battery manufacturing factory, Keller did the foundation and the soil improvement works.

Robert Holczer, Peter Radvanyi –
Keller Mélyépítő, Budapest



► Samsung SDI Ltd commissioned Samsung Engineering Hungary Ltd (its engineer's division) to expand the already operating battery plant in Göd, Hungary. They needed a deep foundation for the buildings of the new plant due to the high loads and the location of the load-bearing soil. The pile drilling work was preceded by detailed soil mechanics studies, as a result of which the geotechnical designers decided to drill CFA piles with different lengths and diameters. In addition, the industrial floor slabs had to be supported by Soilcrete® and vibro stone columns in the high-load areas.

The main challenge was to complete the construction work in high quality and within the deadlines specified in the contract. Furthermore, as Samsung is a global player in its field, they have very strict regulations regarding Health and Safety on site, access restrictions etc. But since Keller is the world leader in geotechnical works, we did not have a problem meeting these specifications.

The organisation of the drilling works was also a big challenge as pile design was done only shortly before execution of the pile works. During the peak periods, three to four CFA piling rigs, two vibrocats and two complete Soilcrete rigs had to work in parallel. In addition, all rigs had to be supplied continuously with concrete, cement, gravel and reinforcement of the right quality.

In total, we drilled approx. 84,000m of CFA piles with diameters varying between 400 and 1,000cm for the foundation works.

In addition, we executed more than 27,000m of vibro stone columns and more than 5,500m of Soilcrete® columns for soil improvement.

The project was divided into different phases, with the first one starting in the first quarter of 2019. The completion of the project was almost two and a half years later



Flood protection

One solution, many techniques: slurry cut-off wall, JG lamella wall, JG full columns, mixed-in-place wall

In light of the increasing frequency of heavy rainfalls and the resulting upsurge of receiving water through the canalisation of streams and rivers – particularly in built-up areas – flood protection is becoming increasingly important. Keller has a variety of sealing options in its repertoire.

Werner Hautz – Keller Grundbau, Innsbruck
Stefan Nitz – Keller Fondazioni, Brixen

► Overflowing streams and rivers, flooded basements and mud-covered roads have been occurring with increasing frequency in recent years, with commensurate press coverage. In the past decades, Keller has become increasingly involved with flood protection.

In addition to several hundred thousand square meters of slurry cut-off walls in the Rhine dams, we once again executed several flood protection projects this year, two of which are described below:

1. Flood protection Haselbach – Waidring

To protect the houses directly adjacent to the Haselbach stream in the municipality of Waidring, the existing dams have been strengthened and upgraded with a slurry wall in the middle of the dams. In the open, where the dam width was around 3.5m, a slurry cut-off wall was executed with Keller's own paddle vibrator. This special adapted paddle vibrator is driven into the subsoil, and the cavity that is created when it is pulled back is then filled with sealing grout. The result is a classic slurry cut-off wall with an average thickness of around 15cm, which serves only as a permeability barrier but has no load bearing function.



In areas where the dam width was less than three metres, the sealing wall was executed by jetgrouting (JG). What was special is that we did not execute full JG columns like in the classic JG method. We adapted the drilling and JG process in a way that the rod assembly is merely oscillated, creating a JG lamella with a width of around 20cm.

In total, around 5,000m² of sealing wall was created.

2. Flood protection Brixen

Flood protection was also improved in Brixen, using a DSM wall (mixed-in-place wall) after the successful sealing of the Adige dams, south of Bozen in South Tyrol.

Here, the stream bed of the Eisack was deepened, to enable it to discharge the flood waters harmlessly for the surrounding buildings. However, this measure would have revealed the foundations of the seawalls, even undercutting them, which is why the entire seawalls were underpinned with JG columns, 'extending' the foundations downwards. This was done using JG columns with a diameter of 160cm in secant form, reinforced by a second row.

In addition, in some of the JG columns single bar reinforcements were placed. In total, the seawall was reinforced to be flood-proof over a total length of 123m. In addition, a JG wall was constructed up



PROJECT INFORMATION

FLOOD PROTECTION HASELBACH

Investor:

Wasserverband Haselbach-Grieselbach

Geotechnical consultant:

Moser-Jaritz + Partner Ziviltchnik GmbH

Quantities:

5,000m² sealing wall

Execution period:

April-May 2022

FLOOD PROTECTION BRIXEN

Investor:

Autonome Provinz Bozen

Geotechnical consultant:

ingena Bozen

Quantities:

1,250m jet grouting columns

Execution period:

January – March 2022

GRAPHIC

Cross section of 'flood protection Haselbach-Waidring'

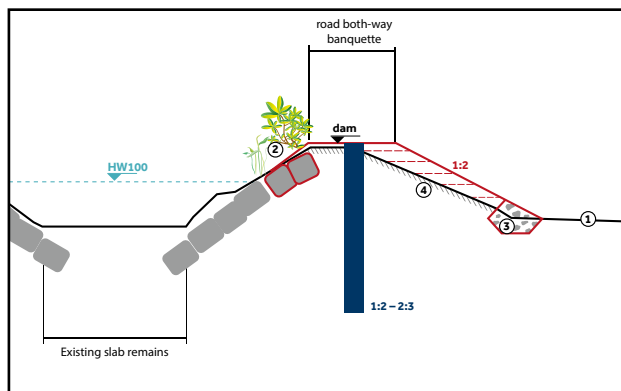

① virgin terrain

② filled and planted gaps

③ friction footing with gravel

④ Extraction of the top layer and laying of a woven filter medium/finish formation from excavated material

■ existing pitched slope ■ cut-off wall
 - - - - fill — newly built load bearing dam

GRAPHIC

Drawing of 'flood protection Brixen'

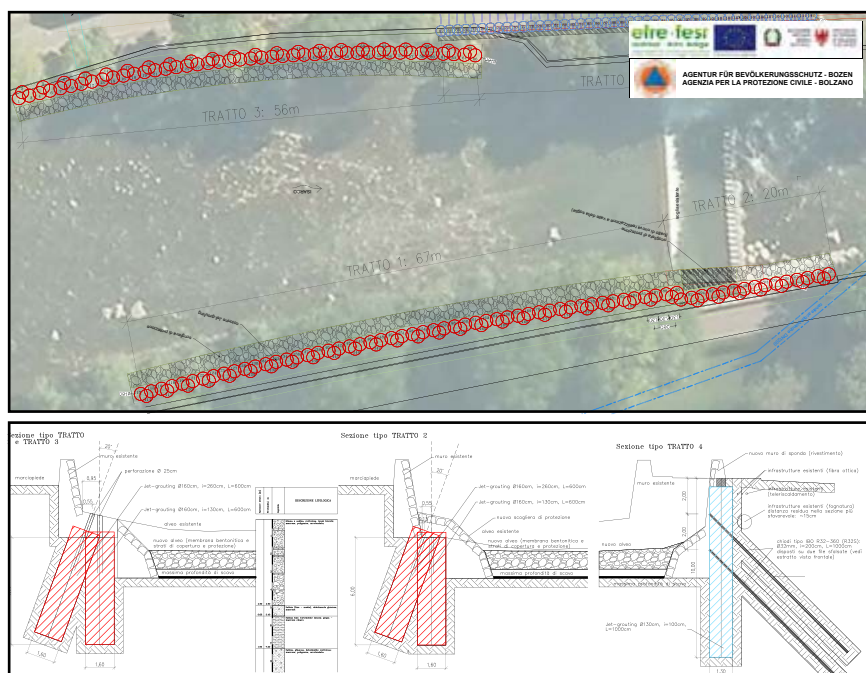

Depending on the requirements, the available space and the environmental framework, Keller has a wide variety of techniques to enhance flood protection systems, now and in the future.



Italy as a vibro market



[View project video here](#)

Last year was a great one for our vibro products in Italy! Keller Fondazioni executed several significant projects where planners and customers have chosen our vibro solutions. These projects were, both public and private ones, to solve various geotechnical issues.

Alessandro Monteferrante – Keller Fondazioni, Verona

▶ Since the last big earthquake happened in 2012 in Emilia, vibro compaction and stone columns are the most favourite and cost-effective technical solutions in Italy to mitigate liquefaction hazards, especially in case of large surfaces and infrastructures.

During the last months, Keller Fondazioni worked – and is still working – for the two largest high-speed railways under construction in Italy.

For the railway between Brescia and Verona, the General Contractor (Consorzio Cepav due, led by Saipem and Impresa Pizzarotti) awarded Keller Fondazioni the second part of the tender to execute vibro stone columns under the road embankments of the new overpass IV35, close to the highway A4, in Sirmione (BS). In total, we completed ca. 50,000m from January to July 2022.



For the same project between Desenzano and Sirmione, near the Garda Lake, Keller was awarded in 2021 the contract from D'Agostino Group to execute ca. 140,000m of vibro mortar columns under the high-speed railway embankments RI42÷RI46. The biggest vibro site ever done in Italy where our team worked with five rigs VC04 along ca. 5km beside the existing highway Milan-Venice and completing the job in time, according to the scheduling planned with the client.

In the last months of 2021, the Consorzio Iricav Due, led by Webuild, awarded Keller Fondazioni the contract to execute the soil improvement works to mitigate the liquefaction hazard for the railway embankment of the new line Verona-Vicenza using stone columns. The site, ca. 90,000m in total, located in Belfiore (VR), is ongoing at the moment; the team is working with two VC04 rigs to execute short (maximum depth of 4–5m) vibro stone columns. The expected end of the site is mid of October 2022, but there are opportunities to acquire additional work on the same project.



With these opportunities in mind, we have the chance to remain the market leader in vibro products in Italy.

Besides the numerous vibro construction sites we did for railways, many clients chose us for the foundations of warehouses, industrial buildings or cableway stations. Our latest exciting experience is in Sicily.

Here, Enel S.p.A. awarded us to execute soil improvement work using vibro compaction inside the existing Power Plant "E. Majorana" in Termini Imerese (PA). This project means a lot to us because we already worked here at the beginning of our journey in Italy more than 20 years ago.

The customer asked for a deep vibro compaction (maximum depth of ca. 17m) to increase the stiffness of the soil (mainly loose to medium dense silty sands) and, in addition, to increase the bearing capacity, reduce the expected settlements and mitigate the risks linked to liquefaction in case of seismic events. The construction site is very challenging. We face a very restrictive logistic context, limited spaces, interferences with other activities, heterogeneous soil conditions and waste disposal to be managed directly with local partners.

But these challenges make our workers and technicians more experienced for the future, so they are ready to deal with similar operative conditions. The target for the future will be a stable and lively vibro market in Italy to repeat the exceptional year and the extraordinary results reached in the current one, a challenge to face mainly by focusing on the experience and enthusiasm of the team.

Expansion of Würth logistics centre Foundation for a new high-rack storage warehouse and office building

Located in an idyllic wine-growing area in the municipality of Neumarkt/Tramin in South Tyrol, Würth is planning an expansion of its corporate headquarters. The new construction includes a new logistics centre with integrated high-rack storage warehouse. Stringent settlement requirements in geotechnically challenging soil conditions, led the client to award a contract to Keller for a foundation with ductile driven piles, including an extensive test programme.

Stefan Nitz, Christian Wetzlmaier –
Keller Fondazioni, Brixen

► Keller Fondazioni had already been awarded a contract to carry out a trial test in 2021. Static load tests on test piles were executed to verify the load settlement behaviour of ductile piles in the given soil. The test piles were arranged to provide an extensive picture of the geology of the future construction field. In addition to static load tests, so-called HPS (HAY proof system) tests were conducted. The latter trial method is a sophisticated static load test procedure that enables separate determination of skin friction and end-bearing behaviour allowing a more detailed examination of the actual pile bearing behaviour.

Based on the results of these tests, the planning team developed a concept for the foundation with ductile driven piles, supported by Arch. Vonmetz Johann (arch.tv Trojer Vonmetz Architekten) in collaboration with the engineering office Holzner & Bertagnolli and in coordination with engineer Sandro Faccioli (the project coordinator at Würth). The key challenge during planning was to develop a foundation concept that met the stringent settlements requirements of a high-rack storage warehouse, and yet was still economical.

After the demolition of an adjacent building, locating all cable lines and preparation of a working platform, the foundation work started in March 2022. Ductile piles for building D (the office building) were the first to be executed. The execution of the piles at the different working levels (cavities, strip foundations and concrete slab) was a big challenge due to restricted accessibility and required advance planning and excellent coordination among the planners and companies involved in the construction.

The deep foundation for building C (high-rack storage warehouse) was executed at a uniform working level, as demanded by the grid-shaped arrangement of the piles. Accordingly, formworks for the strip foundations were set up following work and the gaps were filled with earth materials and compacted in layers.

Further ground investigation of the construction site revealed geotechnically challenging (unstable) ground conditions in higher soil levels. This primarily involved silts, clays and peats with thin intermediate layers of gravel and sand. The presence of peat made it necessary to use sulphate-resistant concrete, to ensure the required durability.

Sufficient load bearing ground conditions were found at deeper levels. As these load bearing layers were found at different depth levels, we had to adjust the lengths of the ductile driven piles accordingly during construction. We executed piles with a maximum length of up to 46m, while the average pile depth was around 35m. The execution parameters and execution criteria were defined in advance and were monitored and optimised during driving process in close coordination with the planning





PROJECT INFORMATION

Investor:

Würth S.r.l.
Projektkoordinator Ing. Sandro Faccioli

Design team:

arch.tv Trojer Vonmetz Architekten
Holzner & Bertagnolli Engineering

Quantities:

approx. **14,600m** ductile driven piles

approx. **275** energy piles

Execution period:

March – May 2022

PHOTO CREDITS/RENDERING: WÜRTH / ARCH.TV

team. We were, of course, able to draw on the information we gained from the test piles and apply it during the execution. As a result, the lengths required due to the changing geology could be adapted efficiently and the foundation was optimised economically.

The sustainable production of energy is a very important topic for Würth. The ductile driven piles are also being used for geothermic power, with the aim of building a zero-impact logistics hub. The basic concept here is to capture energy from the underground, which is needed anyway, and to use it for building heating and – above all – cooling through a heat pump. This demand was met by installing 15-metre-long energy probes in around 70% of the piles. These energy probes were installed by Energreen directly after the piles were executed, while the concrete was still not hardened. Since the energy probes had to be installed in parallel to pile production, top priority was given to coordinating the process and ensuring reliable execution.

During the execution additional load tests (HPS trials/tensile and pressure loads) were executed in different areas of the construction field, to verify the input values for the design

In addition to the test field, carried out ahead of time, the load tests during production and recording of the piling times of each individual pile, additional deformation measurements were taken for the newly constructed building. As building construction progressed, arising vertical deformations were measured and monitored at regular intervals. This made it possible to compare the actual deformations with design values. The deformations measured to date lie within the expected values and confirm the design values. This high standard of quality monitoring is important for the customer, as well as for the planners and – of course – for us as the executing company, helping with efforts for continuous improvement.

Thanks to the good coordination of the involved planners and companies, individual subsections could be handed over to the client without delay. As a result, the schedule was met and the foundation work was completed on time (in just two months).



Infrastructure projects in the Czech Republic with vibro

KELLER CZ has been involved in the Czech market since its establishment in 1993, specializing in executing special foundations using the vibro stone columns technology. Initially, we executed special foundation works for buildings, such as production halls, cooling towers and storage tanks or silos, but since 2003 we have made our mark on highway, road, and railway construction.

Július Mojžiš – KELLER – speciální zakládání, Zlín
Jan Minarčík – KELLER – speciální zakládání, Brno

► During these years, our competitors used vibration technology with hydraulic vibrators on BG carriers, which caused us problems and costed us a few interesting projects, but in the end we stayed lucky and we can call 2003 to 2020 a very favourable time for KELLER CZ. During those years, we were involved in approximately 50 construction projects, ranging from approx. 200 to 61,000m of stone columns, nearly all of them with above-average profits. On railway construction sites in particular, our perfectly tuned organisation and productivity have paid for irreplaceable experts, without whom we could not have managed the construction projects.

In the last three years, however, we have been fundamentally troubled by new competition.

But despite of negative influences, we achieved, in 2021 and 2022, the largest volumes of executed stone columns in the history of KELLER CZ. The fundamental reason for this state of affairs is, paradoxically, the disproportionate concurrence of on-going large-scale infrastructure projects involving

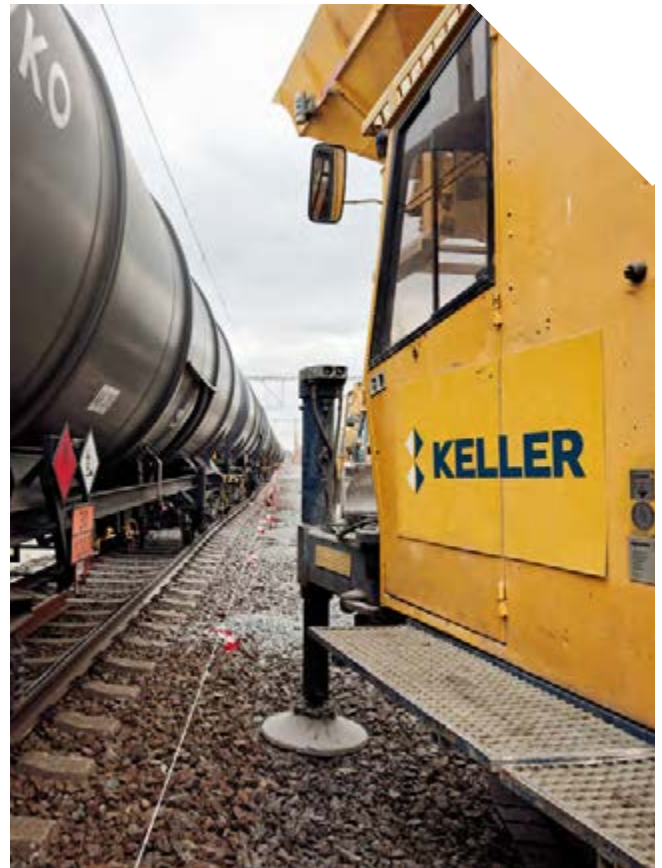

stone columns within that time period, which meant that "everyone got a share of the cake", so to speak. Our company participated successfully in tenders and has completed or is currently finalising the following infrastructure projects:



1. Modernisation of the Dětmarovice-Petrovice track

This project included a restoration of the substructure of the double-track line with vibro stone columns in two segments of the track, measuring approx. 210 to 1,300 metres. The original railway embankment of approx. six metres consisting of clay soils of heterogeneous consistency was reinforced with columns up to a maximum depth of 13 metres. Work for STRABAG and OHLA ŽS was carried out in a total of five stages, with a secondary running track using one to three vibro rigs each time. A total of approx. 4,395 columns was constructed, measuring a total of over 32,000 metres.



2. BC Ústí – Brandýs nad Orlicí

The modernisation of the Brno-Praha railway corridor includes a refurbishment of the track head area at the station of Ústí nad Orlicí. The project proposed an improvement of the railway substructure in a segment of two main tracks with a length of about 2 km. In total, this requires 8,500 stone columns down to a depth of 8.5m. After two stages, February-March 2022 and August-September 2022, we are still in the process of installing approx. 45,000m of stone columns. On the secondary track next to the running track, in the segments under the gates with switches, work is carried out continuously in one-shift cycles. Therefore, it was and is necessary to use two to three TR04 or 05 carriers with BETA vibrators, as well as excavator carriers type JCB JS 260 for MONO vibrators. Due to very strict track deformation requirements, the project required changes in the position of pre-drilling geometry. These were and are provided by Soilmec SR45 or R312 rigs, or, due to low ground clearance under the electrical traction gates, by smaller TESCAR or excavator rigs. We are implementing the project for the EUROVIA company.



3. MÚK Bělotín-Rybi

As part of the construction of a new segment of the D48 highway, a total of 15 structures (bridges or high embankments) made it necessary that the substructure be improved with vibro stone columns. In total, this amounted to about 13,000 stone columns at a total length of approx. 77,000m. Our biggest problem there was low productivity due to complicated geological conditions and a high frequency of mechanical failures. But in the end, we managed to finish this project despite all challenges. We worked on the project for COLAS.

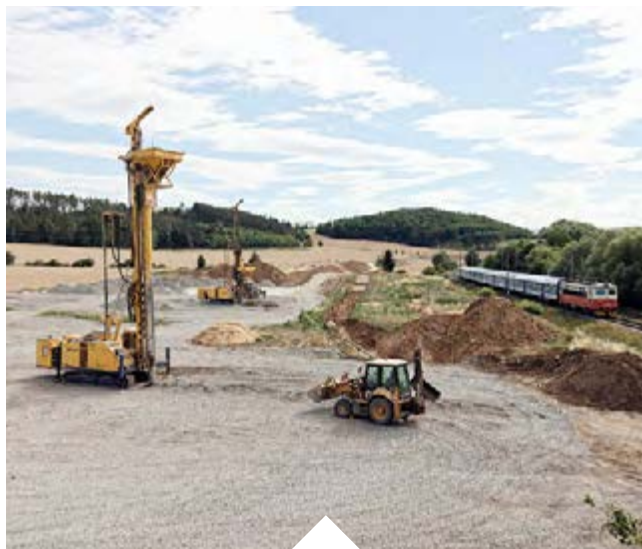

4. Čebín bypass

The project, which had been anticipated by the residents of Čebín for years, began last spring with the improvement of the sublayer of the future road embankments. According to the project, a total of four segments of the new road require approx. 7,800 stone columns with a total length of approx. 30,000m. We are continuously working here for the client (METROSTAV) with one or two TR05 rigs.



5. D49 Hulín-Fryšták

After more than 12 years, this strategic highway project which will ensure a convenient connection to eastern Moravia, has finally received a valid building permit. Working on several bridge structures, we will gradually install nearly 16,000 stone columns for METROSTAV and STRABAG there. Depending on the geological conditions, the depth of these varies from about three to 14 metres, which will result in about 100,000 metres of stone columns.

In closing, we would like to thank our business partners for their confidence in us and we hope that we will successfully and safely complete all the projects.

We look forward to future ones.

Bratislavské podhradie Vydrica

The Vydrica project is located in the capital of Slovakia, in the Old Town district below Bratislava Castle. From a historical point of view, an important trade route to Devín and Marcheg in Austria led through this territory. The location of Bratislavské podhradie was inhabited in the past, but the construction of a new bridge over the Danube in the 1960s (the SNP bridge) made it necessary to redevelop a significant portion of this area, including the historically significant part of Vydrica. Revitalising this location will create a new quarter in the heart of Bratislava, which will expand the centre of the Old Town and seamlessly connect the pedestrian zone with Dunajské nábrežie and the castle hill. Vydrica will thus once again become an important cultural and public area, to which life will return.

Daniela Piliarová – Keller špeciálne zakladanie, Bratislava

► As part of the first project phase and in the area from the embankment towards the castle, three buildings and the Oeserov rad street were sunk below the surrounding terrain level, which creates steeply sloping terrain. On a length of approximately 170 m, a slope of approximately 20–35m height was cut off and had to be permanently secured. According to the STN EN 1997 standard, such cut into a rock wall falls under the 3rd geotechnical category. Geologically, the castle hill consists of surface landfill layers and screes (1–2m thick) on top of the rock subsoil. This assumption was partially based on our previous experience during a construction project near Vydrica, where we implemented a temporary structure made of shotcrete.

Within the Vydrica project, we prepared the proposal for stabilising the castle rock face and then implemented the chosen design (Design & Build). In 2019, we started an auxiliary geological survey to confirm the assumed geological conditions. After core drilling and evaluation of laboratory tests of selected samples, the construction site's main geology engineers defined the subsoil parameters for further calculations. Based on the stability calculation, a shotcrete lining was proposed to secure the cut into the bedrock, using steel rod elements with double-corrosion protection and a system of permanent strand anchors. This type of anchors made of high-strength steel are used in the narrow areas of the cut off.

In such a construction of the 3rd geotechnical category, it is important to constantly monitor the work. This monitoring is done in the way of geodetic measurements of specified points of permanent monitoring of built-in inclinometers and exten-

someters (vertical and horizontal). Forces on dynamometers mounted on permanent strand anchors are monitored at set intervals. At the same time, optical fibres are built in within selected anchors to monitor the behaviour of the anchor elements. Thanks to such measurements, we can check the actual condition of the structure, as well as the castle rock face not only during the construction, but also after its completion and thus confirm the assumptions behind the designed solution. From the point of view of a structural engineer and a contractor, it is important to provide both, which was done by Keller on this project. The collaboration between the execution and the design team ensures that we can react to geological impacts in real time.

As the work progressed, we gained additional knowledge about the Vydrlica area. After consultations with archaeologists and in cooperation with senior structural safety experts and with the consent of the KPU/Regional Heritage Office, historical structures (ice pits, powder room) located on the construction site were protected and structurally secured using our technologies (shotcrete and jet grouting), so that they could become a part of the city in the future.

The project is progressing and sections which we designed and are then implementing are gradually being added.

With the securing of the castle bedrock, a space was gradually opened up for a construction pit with approximate dimensions of 47x160 m for future construction projects at the foot of the cut-off. It was also necessary to design and provide an excavation for the utility network collector under the buildings, whose lower edge is below groundwater level. Such excavation also requires significant sealing expertise. Due to the spatial arrangement of the existing utility networks, this was achieved using elementary jet grouting (Soilcrete without anchoring). The collector excavation deep below the groundwater level had a sealed bottom made of short but large-diameter Soilcrete columns. Together with side walls made of Soilcrete columns, this created a closed, sealed and statically optimised structure.

Since the bedrock gradually lowers towards the Danube river and because of layers of gravel there, it was also necessary to design the foundations for the construction facilities. Individual buildings have common basement floors. At the foot of the rock cut-off, the buildings are based on a reinforced concrete slab founded directly on the bedrock. As the bedrock gradually slopes downward, jet grouting columns with different diameters have been designed under the reinforced concrete slab to transfer the corresponding loads. The Soilcrete columns which were implemented are divided into categories not only according to the diameter of the column, but also to ensure that they reach down to the bedrock, or only into the load-bearing gravel layers. Currently, the construction of the above-mentioned buildings is ongoing.

The second phase of the project, for which the construction of nine more buildings and the continuation of Oeserov rad street



DANIELA PILIAROVÁ ON SITE

(connecting Vydrlica and the Old Town) is planned, also includes a plan to stabilise the castle cliff. On a length of approx. 250m, a permanently secured cut of approx. 20–33m height will be established.

Based on monitoring and the knowledge gained from the first part of the project, a shoring system, using a system of permanent ground anchors, permanent bar elements with double-corrosion protection and shotcrete, was proposed in this section as well. Monitoring was also carried out as part of this phase of the project, and stabilisation work is gradually being carried out up to the level of the Oeserov rad street.

At the same time, projects for the next stages are being prepared, including improvement of the southern side of the embankment and also foundations for planned construction buildings and structures.



Refurbishment of the rail line

“Maribor-Spielfeld section” in Slovenia

The Maribor-Spielfeld rail line is around 16km in length and was built in 1846 as part of the construction works for the historic Südbahn (Southern Railway). In the Austro-Hungarian Empire, it connected the capital city of Vienna with the most important Mediterranean port of Trieste. There are now plans to adapt the line, together with the entire rail network, to comply with European standards and meet the requirements of modern European rail traffic.

Davorin Lesnik – Keller Grundbau, Söding

► The first phase of this section involves the modernisation of the existing single-track line. The second phase, with construction of a second track, will follow to increase its capacity accordingly. This will connect Austria and the adjacent Eastern European region directly with the Mediterranean Sea, with a modernised line along the Baltic-Adriatic rail corridor.

A consortium of construction companies with Pomgrad d.d. as the leading partner has taken on the works in this section, worth around EUR 290 million. Keller was awarded by the consortium to execute electrical isolated permanent ground anchors.

The challenging conditions on site, execution of drilling works must be done right next to active rail traffic, required the use of an anchor drilling rig with an especially shortened carriage, since only a working width of 4.8 to 6m was available along the existing track.

The first eight metres of the soil consists of backfills, followed by strongly weathered, over-consolidated clay silt (“opok”). Intermediate sand layers with heavy water flow proved to be



LEAK TEST OF THE INSTALLED

anchors in accordance with the ÖNORM B 4456

a particular challenge, resulting in massive overconsumption of cement grout (five times more than the theoretical volume) during the anchor grouting process.

So far, 60 permanent anchors (four strands) with lengths between 34 and 37m have been executed, in accordance with the contract. According to the Swiss SIA 267 and 267/1 standards, which are in force in Slovenia, permanent anchors must be built with electrical insulation and tested after construction for ERMI electrical insulation resistance, using a calibrated, certified ohm meter.

Additional quality checks (leak test in accordance with the new ÖNORM B4456, which applies in Austria) made it possible to identify any permanent anchor that was damaged during





PROJECT INFORMATION

Investor:

Ministerium für die Infrastruktur –
Direktion Republik Slowenien für die
Infrastruktur

Designer:

Lineal d.o.o., Maribor

Geological survey:

IRGO Consulting d.o.o., Ljubljana

Customer:

Pomgrad d.d., Murska Sobota

Quantities:

2,200m² permanent strand
anchors

Execution period:

June – July 2022

transport or handling at the construction site in time and adapt it accordingly. A permanent anchor is considered compliant with the standard when the electrical resistance measurement at the strand measures more than 0.1 Ω .

In the interim, the contract has been expanded by another approx. 40 permanent anchors, which will be executed in January 2023.

The works were completed to the full satisfaction of all the project participants and compliant with all necessary provisions of the country-specific quality standards.



EXECUTION OF WORKS

right next to active rail traffic

#buildingtogether

Apprenticeship campaign at Keller

Changing requirements of the labour market, the evolving needs of young people and growing expectations of the working world are our challenges. That's why we at Keller intensified our focus on apprenticeships this year. The result was a completely new approach to our vision of Keller Grundbau as an apprenticeship employer. The first apprenticeship day, on 13 May 2022, has been the highlight so far.

Daniela Stadler – Keller Grundbau, Söding

► This year, Keller thought of something special for its apprenticeship activities: a brand-new apprenticeship campaign that culminated in an apprenticeship day.

But let's start at the beginning:

Keller has a successful, long-standing track record of training young people in three technical career paths: agricultural and construction machinery technician, mechatronics engineer and metalworking technician. To maintain enthusiasm for these professions among young people, we took deep dives into these professions and asked many questions on behalf of the young people: Just what lies behind this profession? Metalworking technician is a broad field – what specialisation can be learned at Keller? What do you learn during the respective apprenticeship years? And how does an apprenticeship at Keller work at all?

The answers we found gave rise to a page for apprenticeships on our website. We've made all the information about apprenticeships available on our [website](#) in an attractive, informative format

Armed with the occupational profiles, all other information about apprenticeships at Keller and specifically designed advertising materials, the journey continued with an extensive social media campaign and promotions in schools. This was accompanied by broad press coverage in a variety of daily, trade and local papers.



Beyond all this, there was also another special highlight: This year, we offered an apprenticeship as a financial accounting and bookkeeping assistant for the first time, adding apprenticeships in the commercial sector to the technical training we already offered.

Our promotion campaign proved to be effective: We won people over and quadrupled the number of applications for our open apprenticeships compared to the previous year.

Our highlight: an opportunity to experience Keller hands-on.

To do so, we extended invitations to our first apprenticeship day on 13 May 2022. We welcomed interested young people, parents, local politicians and other companies from cross-company apprenticeship education and the Austrian Employment Service. Over the course of the day, the visitors had the opportunity to interact with current apprentices, instructors and other colleagues from the company, to get better insights into everyday work at Keller. Our current apprentices also demonstrated their skills and presented the respective occupational profiles in one-to-one talks.



Aside from getting to know our company, our colleagues and our activities, the applicants also experienced part of our new recruiting process: They all took part in a theoretical test covering the most important skills/qualifications of the respective professions and showed their skills in practical exercises. Even though their nervousness was palpable at times, we enjoyed seeing the happy faces of the applicants and their satisfied parents and other representatives in the end.

Our takeaway: Our new approach was very successful, as reflected in the huge increase in applications, and we were able to win people over to Keller Grundbau once again as an attractive place to work.



Video from
apprentice day
on Youtube



#buildingtogether

Finanz- und Rechnungswesenassistent/in

Lehrdauer: 3 Jahre

Als Lehrling bekommst du jede Menge Unterstützung von uns:
Ein eigenes Ausbildungsprogramm in Söding und zusätzliche Ausbildungsprogramme sowie weitere Benefits (z.B. Leihlingsprämien, Ausfallgel.com, ...)

Finanz- und Rechnungswesenassistent/innen arbeiten in den Gebieten des betrieblichen Rechnungswesens, wie z. B. Buchhaltung oder Kostenrechnung. Die Durchführung laufender Buchhaltungsarbeiten (z. B. das Erfassen von Eingangsrechnungen und Lieferrechnungen, Kundenbuchhaltung), die Durchführung von Baustellenrechnungen oder die Unterstützung von Investoren ermöglichen verlässliche Informationen über die finanzielle Lage des Unternehmens zu liefern. Diese Informationen sind sehr wichtige Bestandteile für Entscheidungen des Managements. Neben klassischen Buchhaltungsarbeiten gehören auch die Administration einschlägiger Dokumentation oder Mithilfe bei der Vorbereitung für den Jahresabschluss zum Berufsbild. Die kaufmännische Unterstützung auf unseren Baustellen bringt im letzten Lehrjahr noch zusätzlich Abwechslung in den vielfältigen Beruf.

Building your future together: kellergrundbau.at/karriere/lehre #Buildingtogether

Gleich hier alle Infos und Videos anschauen

Our events in SEN

The masks are (finally) off

After more than two years of a forced break due to COVID, it was time this year to finally meet again in person. We didn't miss an opportunity, holding trade fairs, conferences, internal and external meetings, and company celebrations, too.

► For example, our Swedish colleagues organised a family day on our premises in Lindome in June as part of Global Day of Parents. There was plenty of food and drink, and fun activities for our employees and their families to enjoy the day.

In Italy, which has suffered immensely from the pandemic in recent years, the time came in September. All colleagues celebrated the 25th anniversary of Keller Fondazioni together with their families.

But we were also in a party mood in Austria. Unfortunately, we had to cancel our Barbara celebrations in 2020 and 2021. In 2022, the time had finally come to organise a summer party at our yard in Söding. We invited all active and retired colleagues to celebrate together, and it was a nice feeling to see everyone again. We also used this event to honour 86 long-serving employees, who've celebrated between ten and 35-year anniversaries with Keller over the last three years.

In addition to the fun events, we also attended trade fairs and conferences, such as the 'Austrian Geotechnics Conference' (ÖGT) and the 'Baukongress' in Vienna or the Christian Veder Colloquium in Graz or the Recy & Depo Tech in Leoben. During these fairs, we welcomed many visitors to our booth. We would like to take this opportunity to thank all those who attended once again; we were pleased to have so many interesting discussions with you.

Since we are also looking to the future, as with previous years, colleagues from our HR and Operations functions visited technical high schools and universities, including on their career days. Locations included the University of Natural Resources and Life Sciences Vienna (BOKU), the TU Graz, but also at the HTL Villach, Pinkafeld and Rankweil. It was really good to see what the younger generations think of our company.

We hope you have enjoyed this brief glimpse into our 2022. 2023 is ready for many new events and activities, and we look forward to seeing you (again).



25 years time for a big celebration!

Keller Fondazioni recently celebrated 25 years in the Italian market by hosting a big party on Lake Garda with our employees and their families.

Emanuele Nanni – Keller Fondazioni, Verona



► It was 1997,

when Keller began its activity in Italy, looking for the best strategies to grow further and further. The business was aiming to consolidate its position within a challenging market that was not always aware of the quality and innovation we offered. But through thick and thin, we succeeded, and went on to carry out many important geotechnical works in strategic infrastructure projects.

10th of September 2022 was the perfect date to celebrate our 25-year accomplishment, and we gathered at the Antiche Mura restaurant in Riva del Garda to do so.

This event was a fantastic opportunity to strengthen our team spirit and bring colleagues closer together. We were delighted to share the evening with our family members, as well as external consultants who add great value to Keller Fondazioni and attended with pleasure.

This same team spirit was the driving force and the soul behind our milestone achievements in an increasingly challenging market. A market which has been

affected by major events such as the pandemic and the war in Ukraine, and their resultant economic impact.

Nevertheless, over the past two years, the 'Keller spirit' and everyone's commitment have made it possible to overcome many a challenge, and we've achieved better results than ever before.

The key to success

Since it's not all about numbers, but more about the people, Emanuele Nanni, our managing director for Italy, had the pleasure of commemorating the 25 years and award co-workers who have been, and were previously, part of Keller for more than ten years.

With affection and humour, we mentioned and remembered all those long-serving colleagues, past and present. They have contributed to the growth and development of the Italian branch with their hard work and professionalism.

Sharing 25 years of memories was not easy. Each construction site is a part of us and our history. We recalled the most

significant ones and those that show technological innovation for the entire group.

These include "Galleria Scianina" and the "Metro B1" in Rome, making our way to "Viadotto Oglio e Serio's high velocity" and "Sottoattraversamento Isarco".

And finally, the high-velocity project for the Brescia-Verona-Vicenza route on which, for the last three years, we've played the main role, thanks to our vibro compaction techniques.

We finished our special event by shining the spotlight on our very successful colleagues in South Tyrol. Over the last few years, especially, they have succeeded in winning much great work, thanks to the competent advice they offer to the clients, and have executed those projects successfully. Due to this competency, they were and are a very important partner in increasing our turnover and profitability.

"Always stronger than before"



HS2 is Europe's largest infrastructure project costing around £100 billion.

Not only is it a hugely important job for Keller, it's also an opportunity to test carbon-cutting measures that could have a major impact on our projects around the world. At Keller, we're committed to improving impact on the environment. As a large-scale, long-term, multifaceted project, HS2 is the perfect opportunity for our UK team to explore ways we can do this through various carbon-reduction methods.



► "HS2 is a very sustainability-conscious client, so we have been able to trial a lot of sustainability initiatives. Our aim was to see what we could improve and then put together a report for early 2022 to establish guidance and processes for the wider company," said David De Sousa Neto, Deputy UK Managing Director.

The first change, he says, was looking at alternative fuel and energy sources for the machinery. In particular, this included running static plant with electricity where possible rather than diesel, and replacing diesel with hydrotreated vegetable oil (HVO) in several drilling rigs. HVO can be used in regular diesel engines and, alt-

hough it costs around five to 10 percent more than diesel, it reduces CO₂ by 90 percent.

"Within a month, the difference was obvious, so changing was a no-brainer," says David. "The only problem is that we're not the only ones wanting to use HVO, and so there's a potential supply issue in the short-to-medium term."

Another carbon saving, which has also had direct benefits in terms of reducing time and cost, has come through optimising the design of some of the foundation elements. The team has been able to reduce the thickness of diaphragm wall panels – and therefore the amount of concrete needed – by 20%, from 1.2m to 1m, without compromising quality.

"The team has also significantly reduced cement consumption when grouting rock fissures ahead of bored pile and diaphragm wall construction," said Paul Marsden, Product Development Manager. "Instead of using microfine cement grout to reduce permeability, we used a cement bentonite grout and only targeted the largest fissures where leakage of the bentonite support fluid was a risk. This allowed us to use much less cement in the grout mix and use less grout overall."

In another part of the HS2 project, where Keller is installing large-diameter bored piles, the team has found ways to recycle and reuse waste bentonite, drastically reducing the amount going to landfill and the associated carbon emissions of transportation.

"Trials like this give you the right mindset to look at where you can save waste and make processes more efficient," said Paul. "But as with all these activities, there has to be a balance between sustainability and other factors such as cost, time and impact on quality. "For example, although the HVO costs a little more, the carbon reduction is huge and simple to implement. With the waste bentonite, recycling only really becomes viable if the project is medium to large in size, because of the cost of the extra equipment and people required."

Paul, David and the HS2 team have so far saved over 2,600 tonnes of CO₂e in this trial. That's the equivalent of over 565

cars running for a year. But the team are not stopping there. They are also finalising a guide that will pull together all their facts, figures and learnings. This practical and visual carbon reduction guide will then be shared with the rest of the organisation to help support carbon reduction across Keller. "Some of these changes have been challenging simply because we've not done them before," said David. "But hopefully our report will help with that. I think what we'll show is that sustainability doesn't have to be this big, complicated thing, there's a lot of low-hanging fruit – like the change in fuel or design optimisation – that projects, no matter the size, can implement."



Keller improves employee wellbeing with first-ever global health initiative

As part of our ongoing focus on enhancing employee wellbeing, at home and at work, Keller ran its first-ever global health challenge over the summer months this year.

We signed up to the health and wellness platform, VP GO, run by Virgin Pulse which designs technology that cultivates good lifestyle habits.

More than 1,500 Keller employees from across globe joined the platform, which allows you to track your exercise (anything from running to gardening) and wellness behaviours (eg step count, sleep time, nutrition); interact with colleagues; and get useful information and support on how to improve your physical and mental health and wellbeing.

The main part of VP GO was the steps challenge – Destination GO – which saw around 200 teams of seven track their workouts, which were then converted to distances walked across the world. The aim was to travel as far as possible, virtually, before the challenge ended and in total participants racked up over five hundred million steps and 260,000 miles! There were some great team names too, such as 'Not fast just furious', 'California Dreaming', 'The Legal Eagles' and 'Mission Slimpossible'.

The challenge was a great way to help our colleagues forge healthier lifestyles and focus more on their wellbeing, and we were pleased to see that it really brought together people from different countries, teams and roles, who might not normally interact with one another.

Our foundations of wellbeing

Keller's participation in this initiative builds on the launch of our Foundations of Wellbeing framework in 2021, which focuses on improved mental and physical wellbeing, at home and at work, in five specific areas: Body, Mind, Community, Growth and Financial security.

[You can find more information here](#)



global strength and local focus

 [linkedin.com/company/keller](https://www.linkedin.com/company/keller)

 [youtube.com/c/KellerGroup](https://www.youtube.com/c/KellerGroup)

www.keller.com

